

Rhombicuboctahedron

Print the model on three different colored papers

1. Start with part 1 and glue part 2 on the tab of part 1 with the number 2.
 2. Glue part 3 on the parts 1 and 2 on the tab(s) with the number 3.
 3. Glue part 4 on the parts 1, 2 and 3 on the tab(s) with the number 4.
- Etc.

Color 1

Part 1

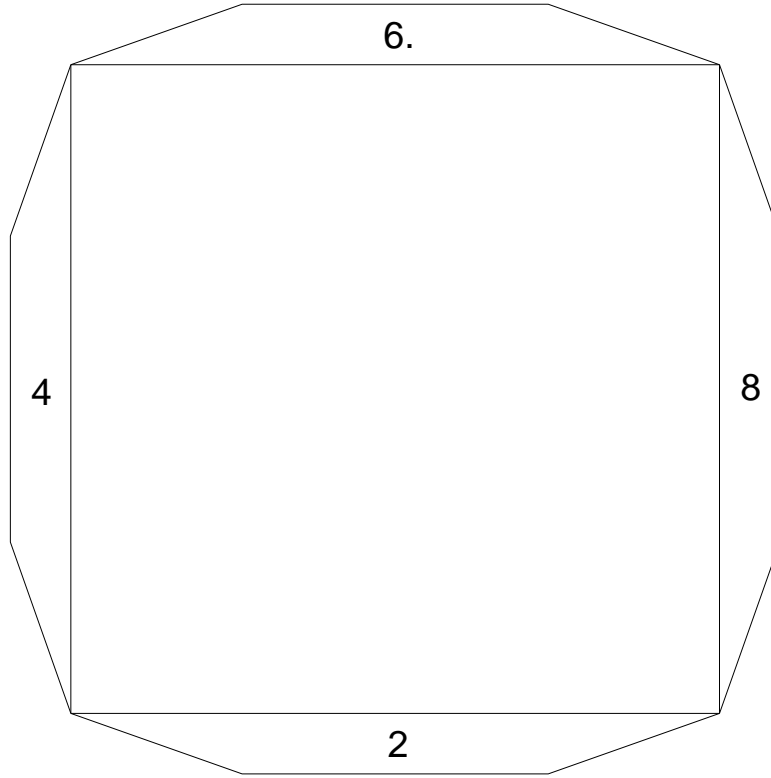

Part 11

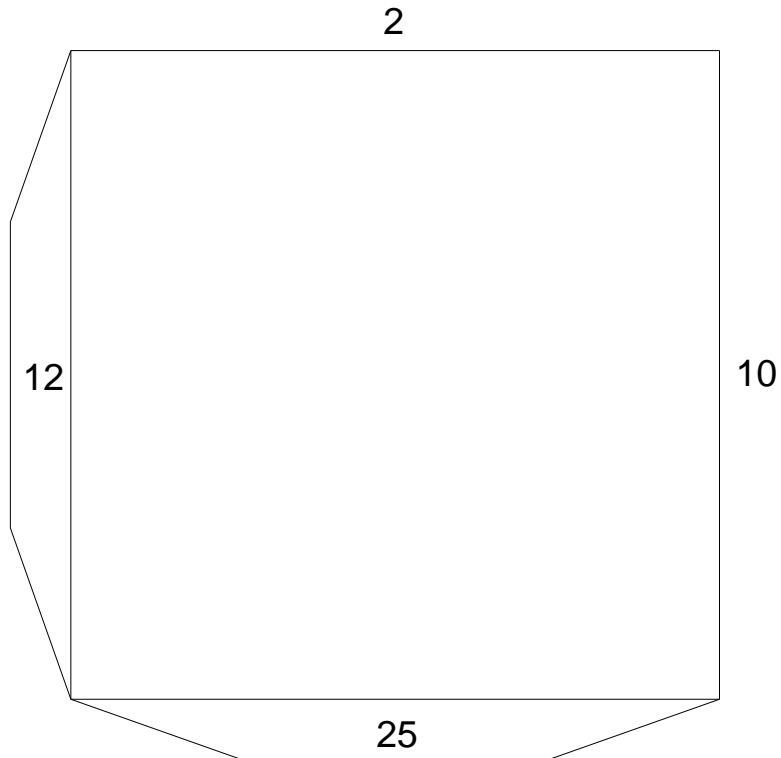

Rhombicuboctahedron

Color 1

Part 13

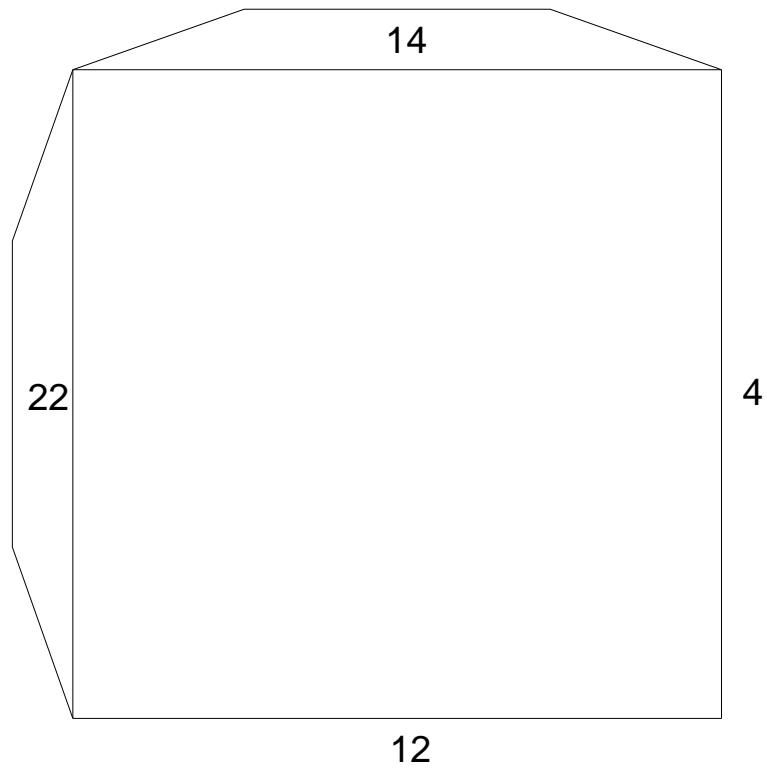

Part 15

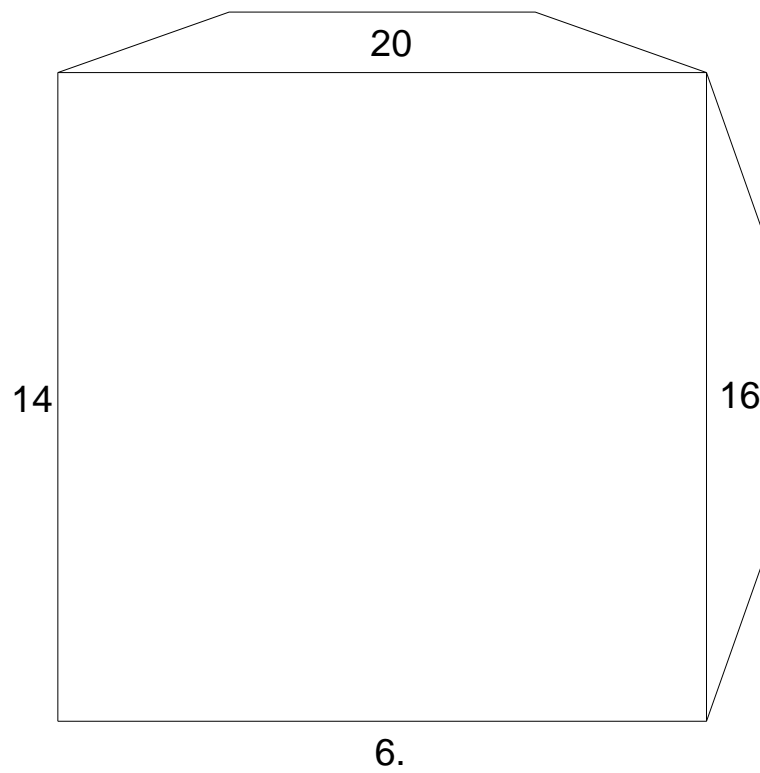

Rhombicuboctahedron

Color 1

Part 17

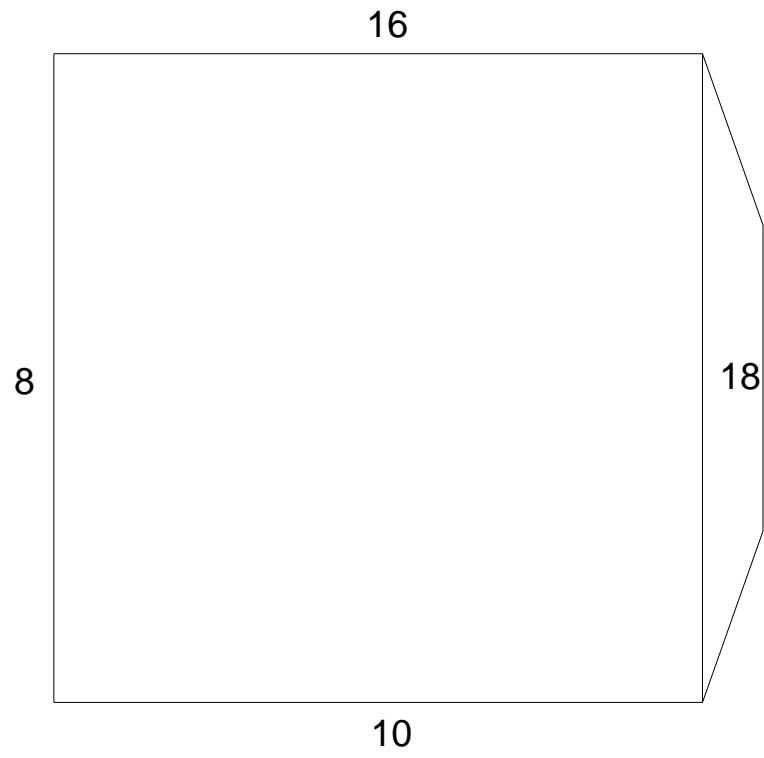

Part 26

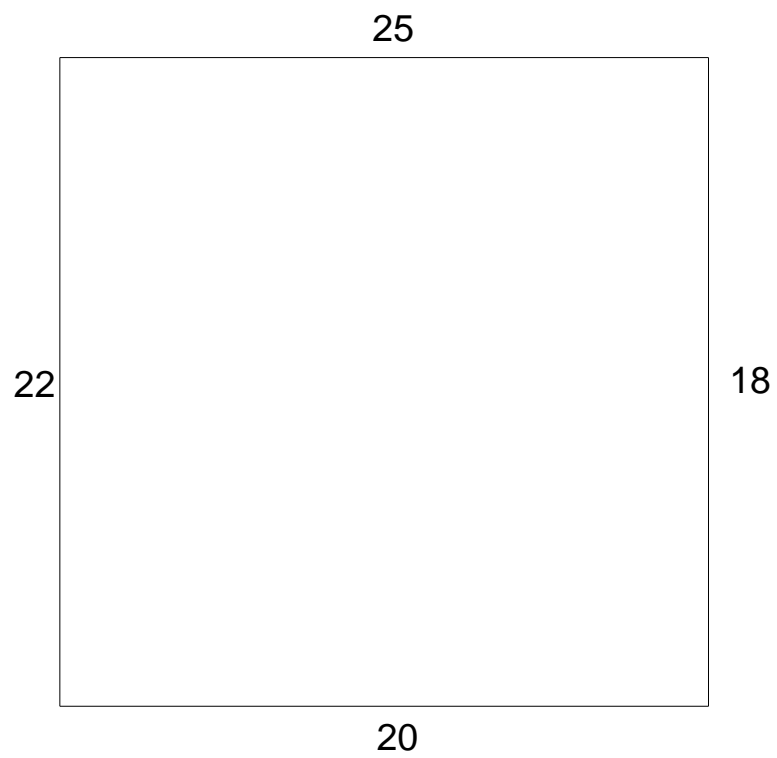

Rhombicuboctahedron

Color 2

Part 2

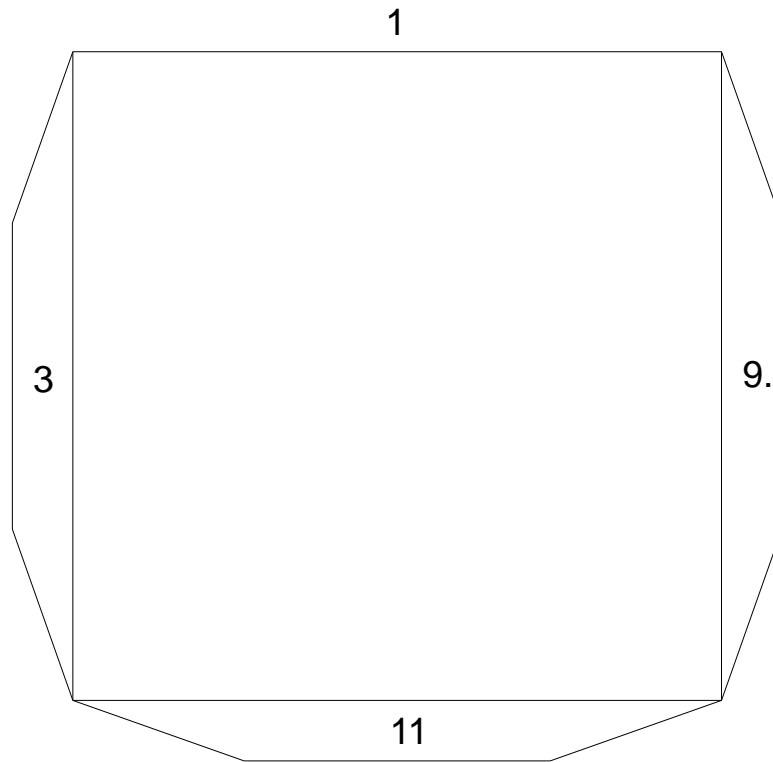

Part 4

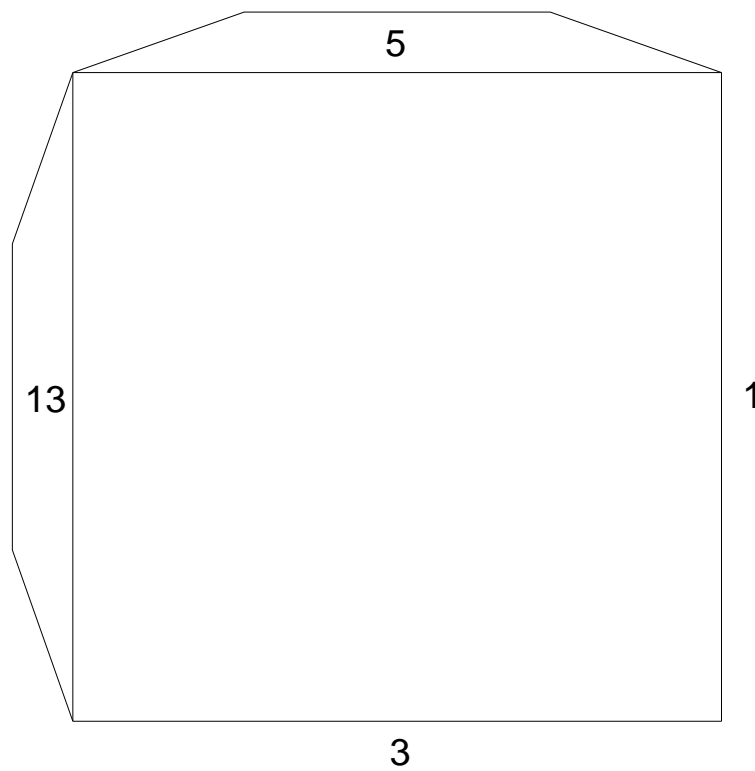

Rhombicuboctahedron

Color 2

Part 6.

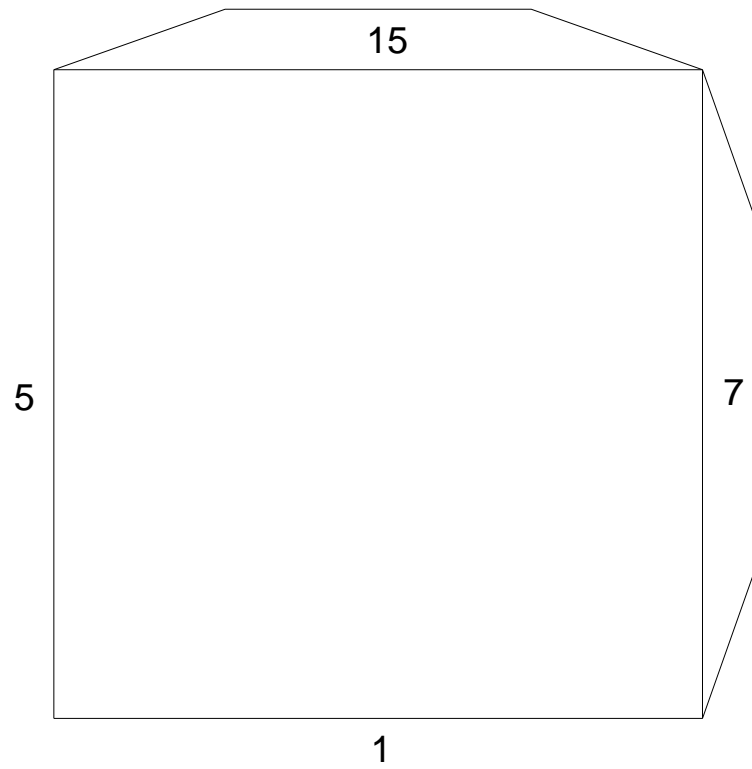

Part 8

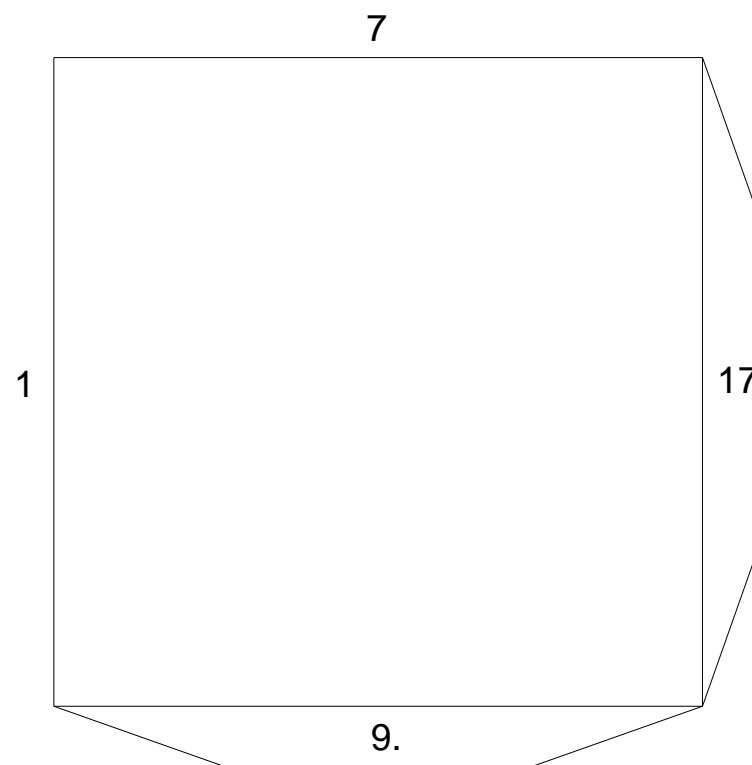

Rhombicuboctahedron

Color 2

Part 10

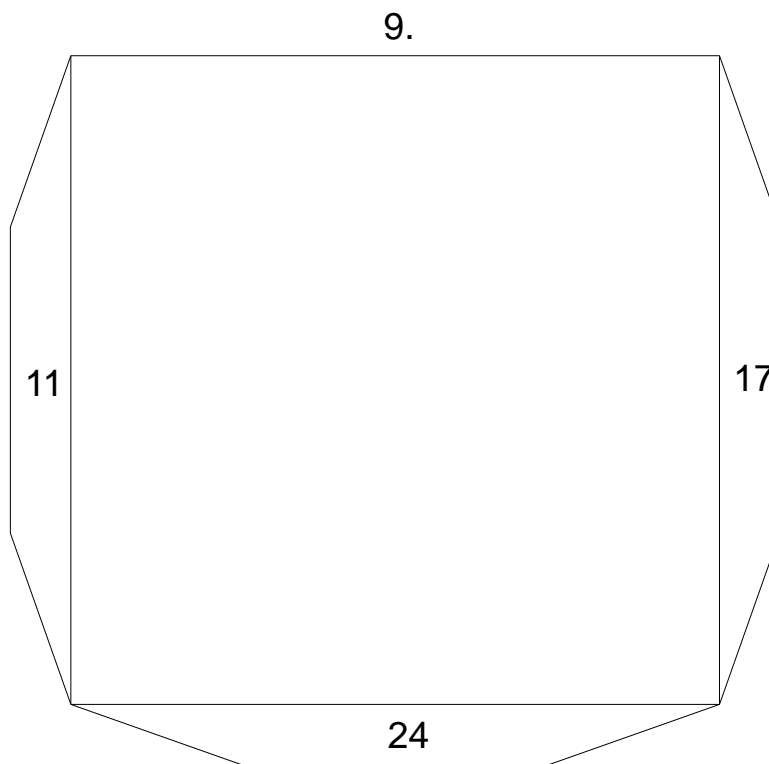

Part 12

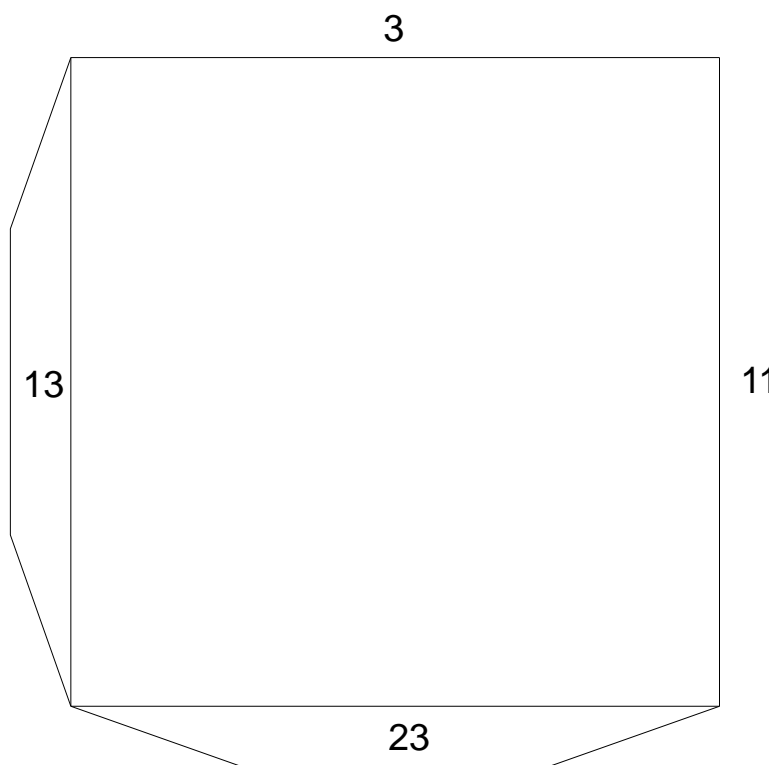

Rhombicuboctahedron

Color 2

Part 14

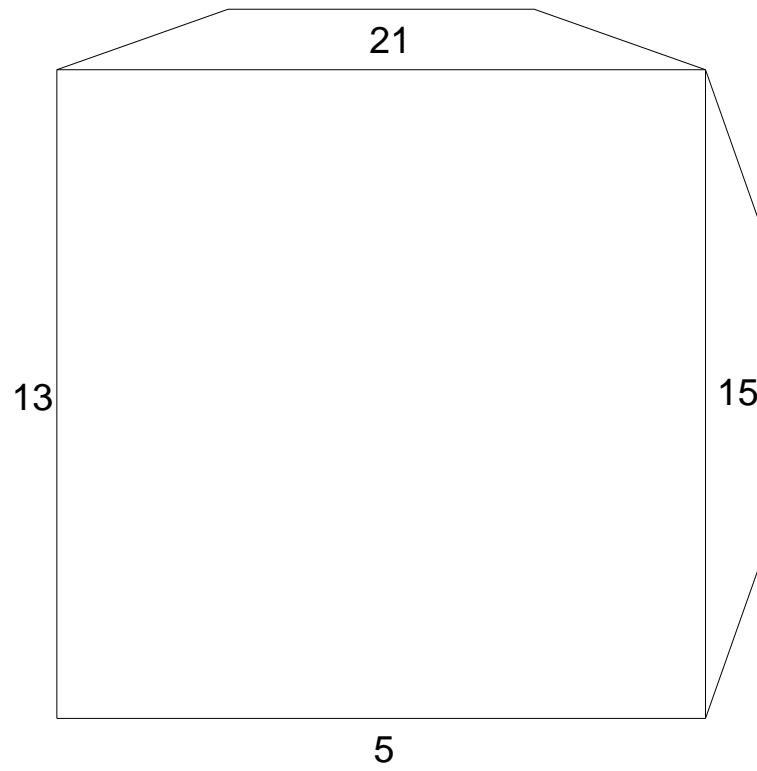

Part 16

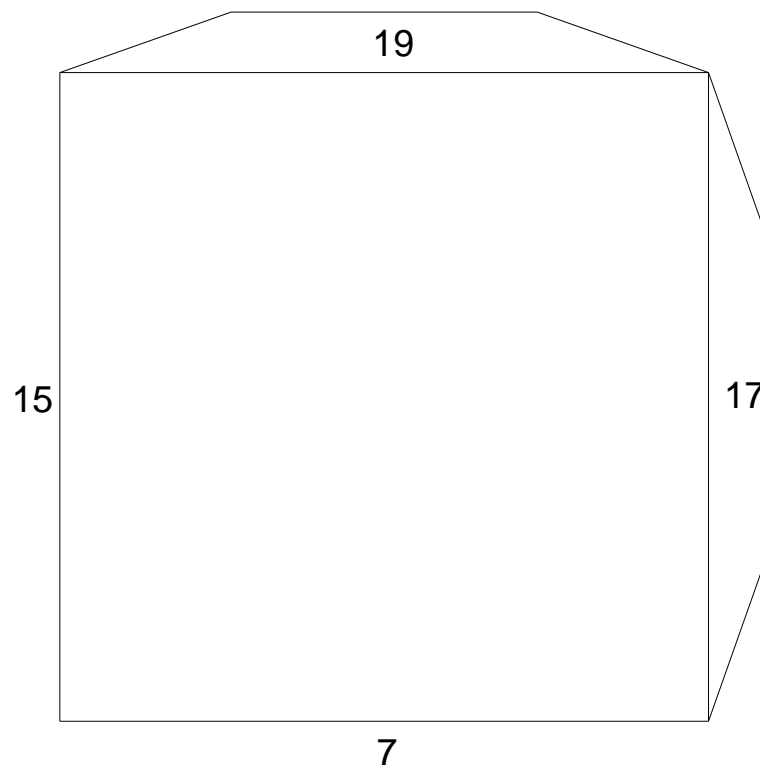

Rhombicuboctahedron

Color 2

Part 18

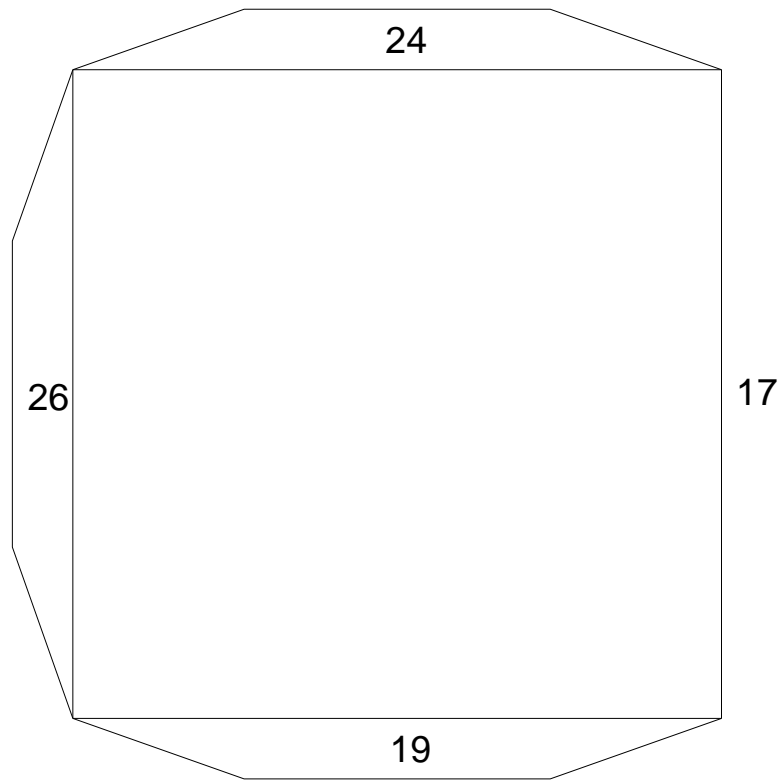

Part 20

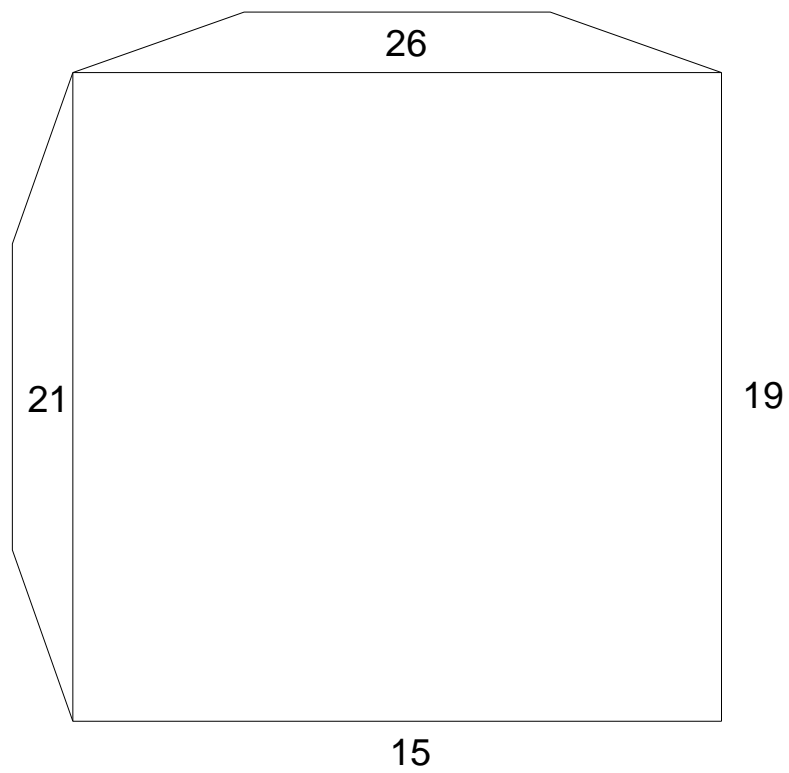

Rhombicuboctahedron

Color 2

Part 22

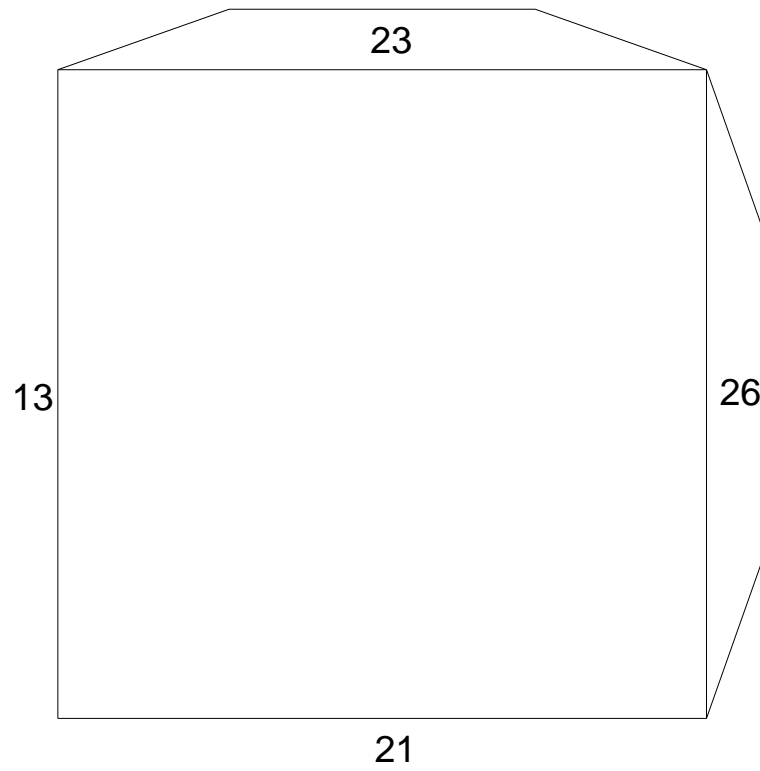

Part 25

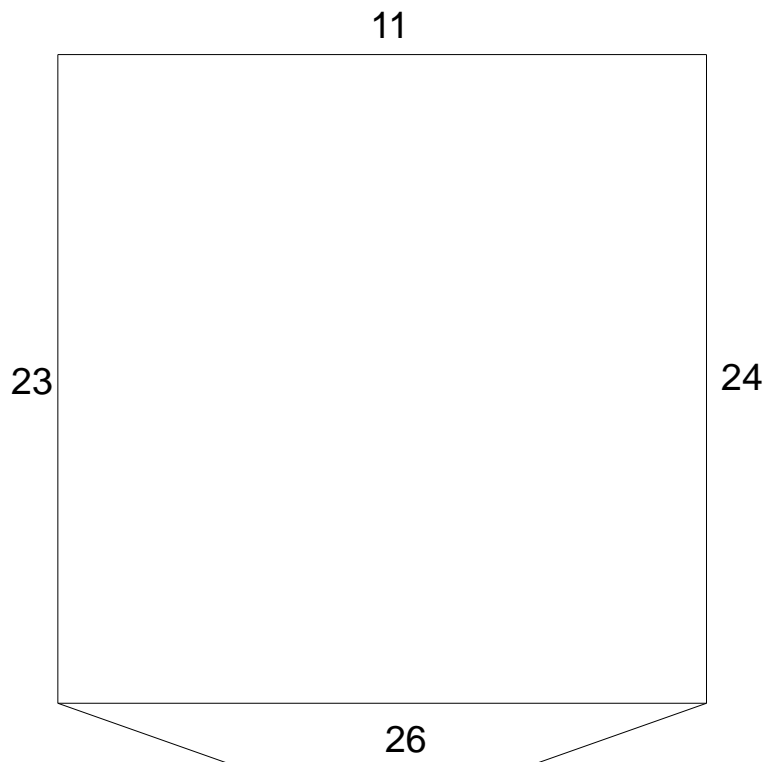

Rhombicuboctahedron

Color 3

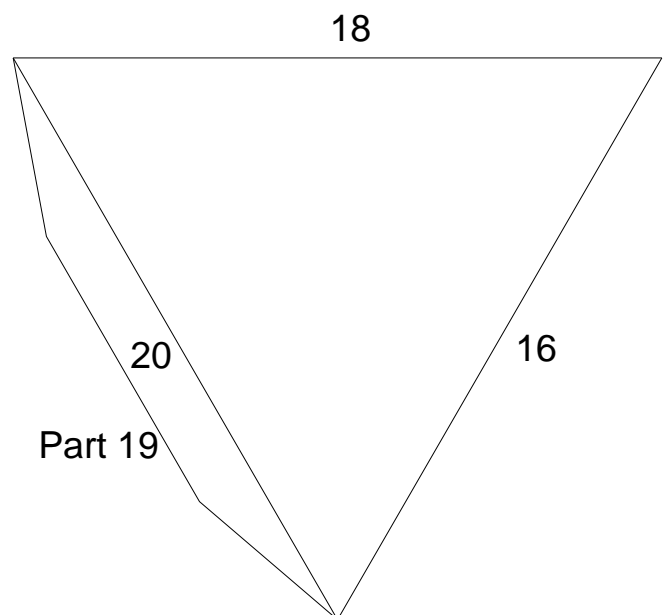
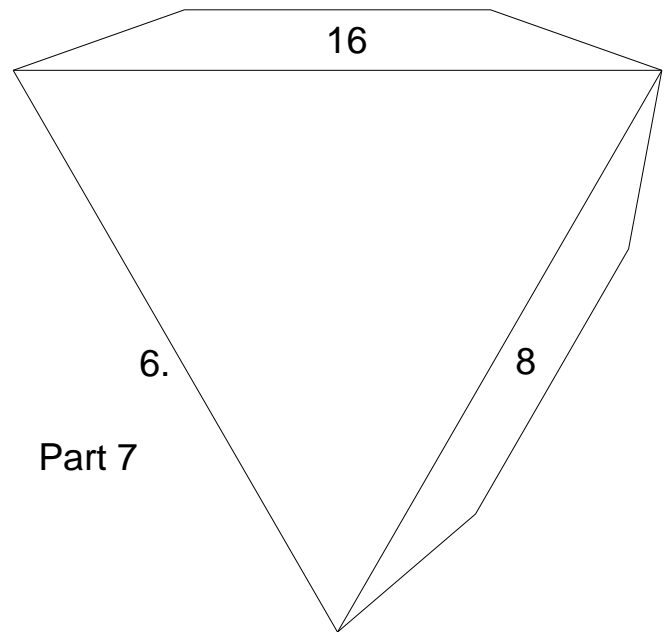
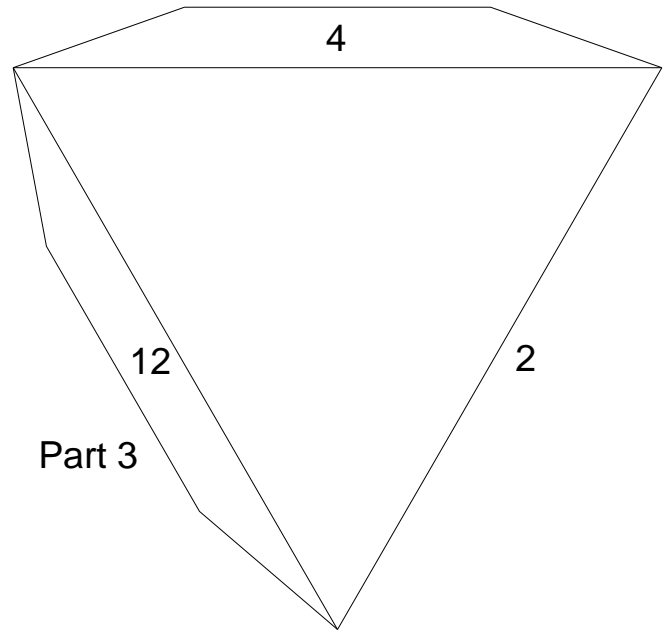
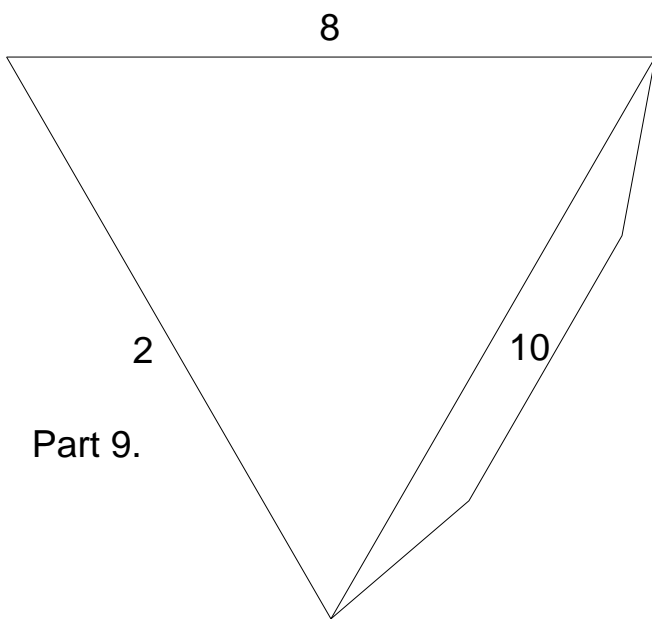
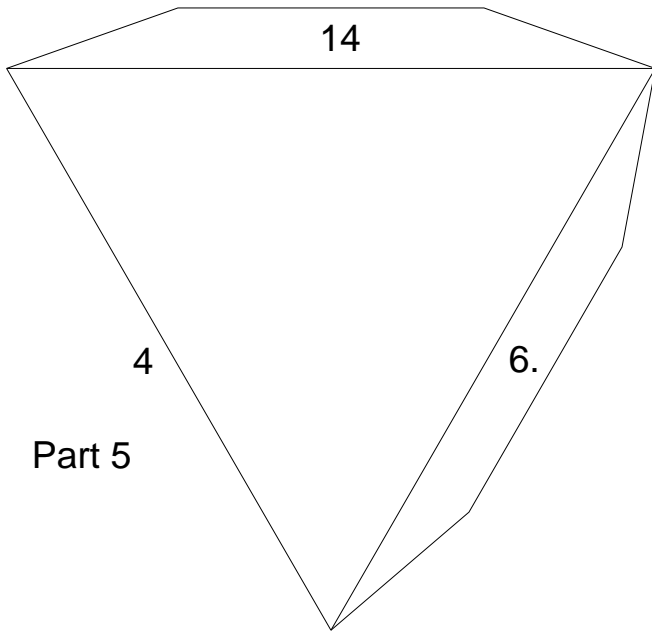

Rhombicuboctahedron

Color 3

