

**Paper Models of Polyhedra
Collection 7 uncolored:
Platonic solids with duals inside**

- Dodecahedron in two parts with a Icosahedron inside
- Cube in two parts with a Octahedron inside
- Octahedron in two parts with a Cube Inside
- Icosahedron in two parts with a Dodecahedron inside
- Tetrahedron in two parts with a Tetrahedron inside
- Dodecahedron in two parts with a Cube inside (no duals)

Copyrights © 2007 Gijs Korthals Altes
All rights reserved .
<http://www.korthalsaltes.com>
Email: inf@korthalsaltes.com

Dodecahedron divided in two parts (part 1)

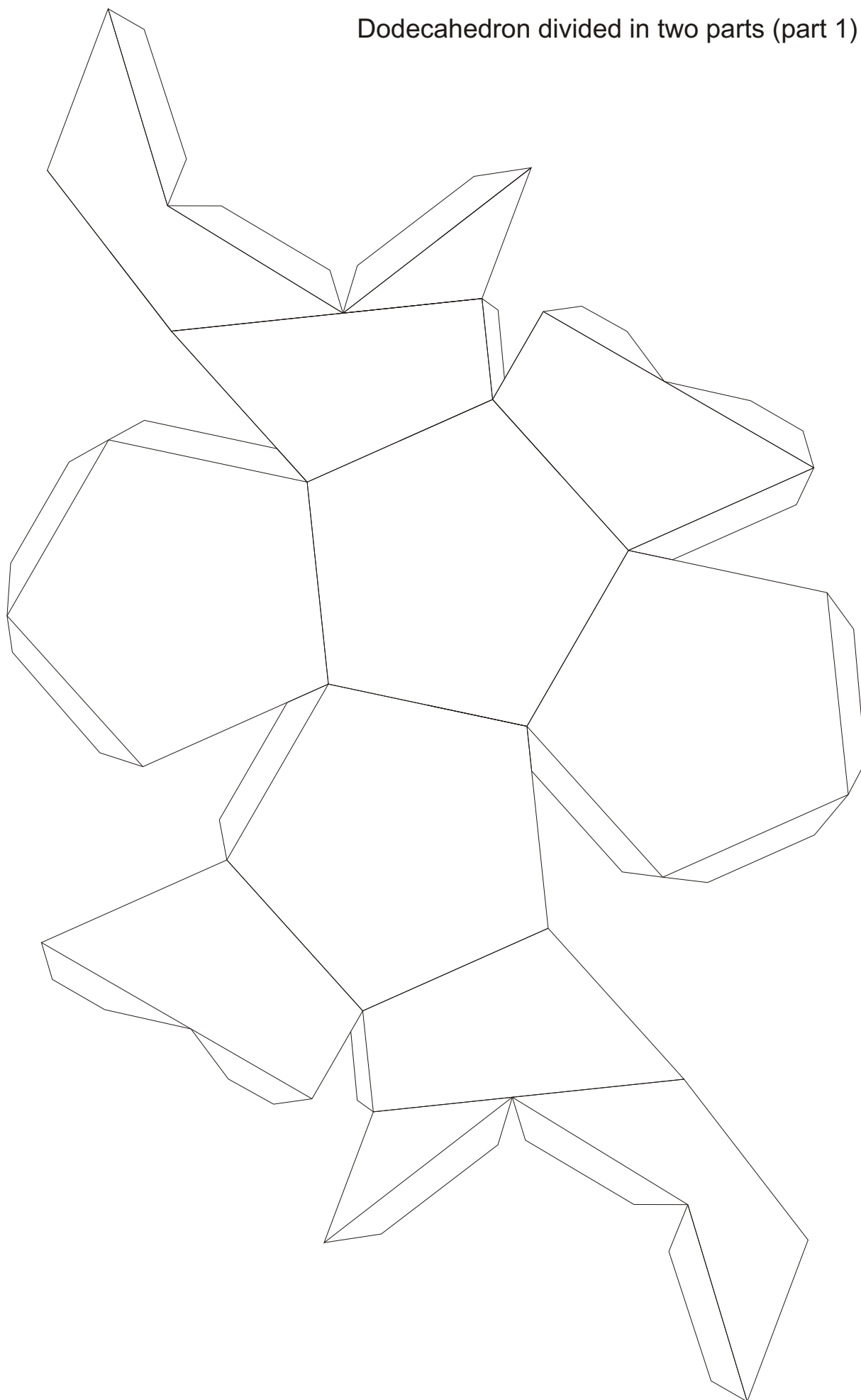

Dodecahedron divided in two parts (part 2)

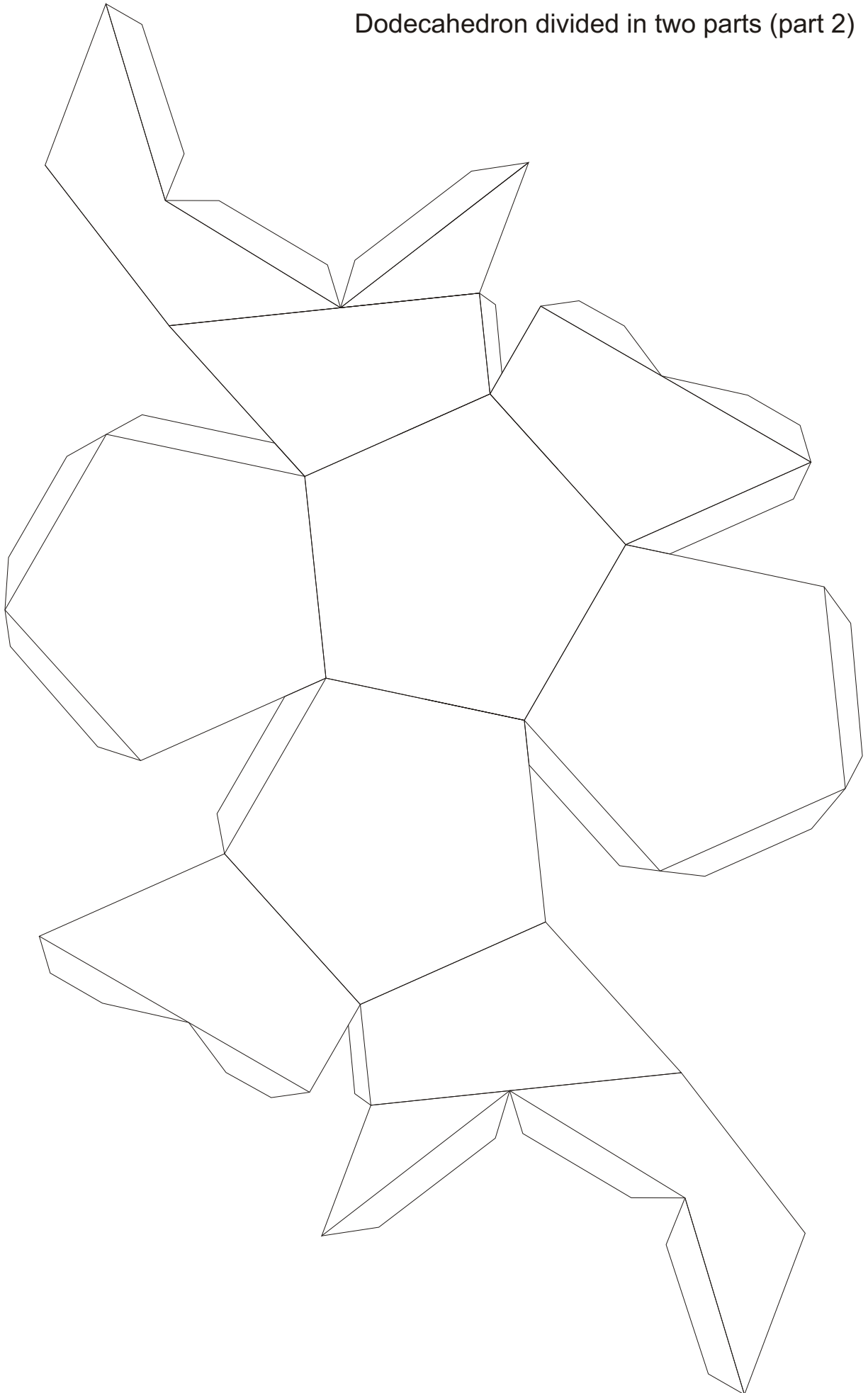

Icosahedral interior of the dodecahedron

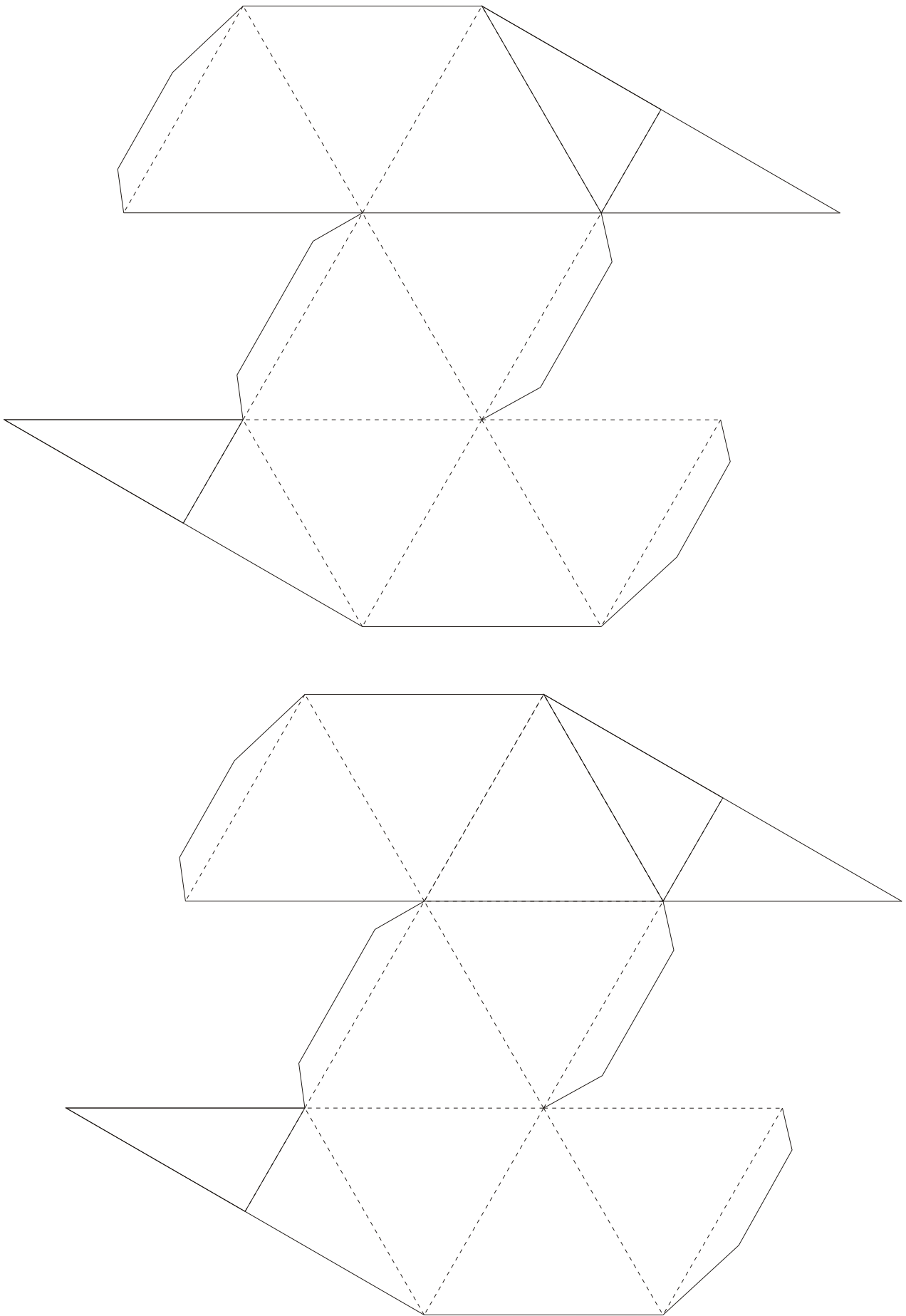

Icosahedron

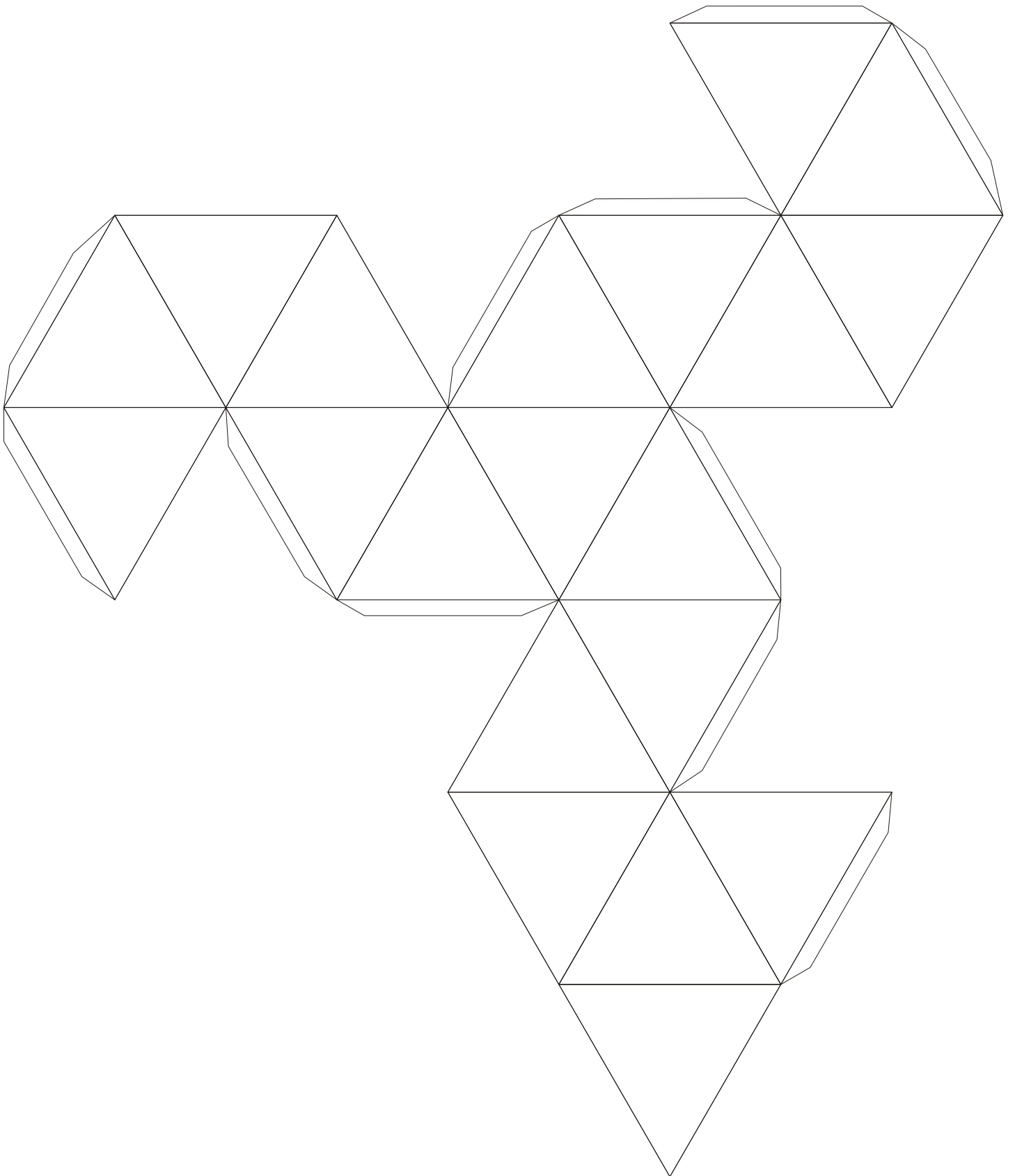

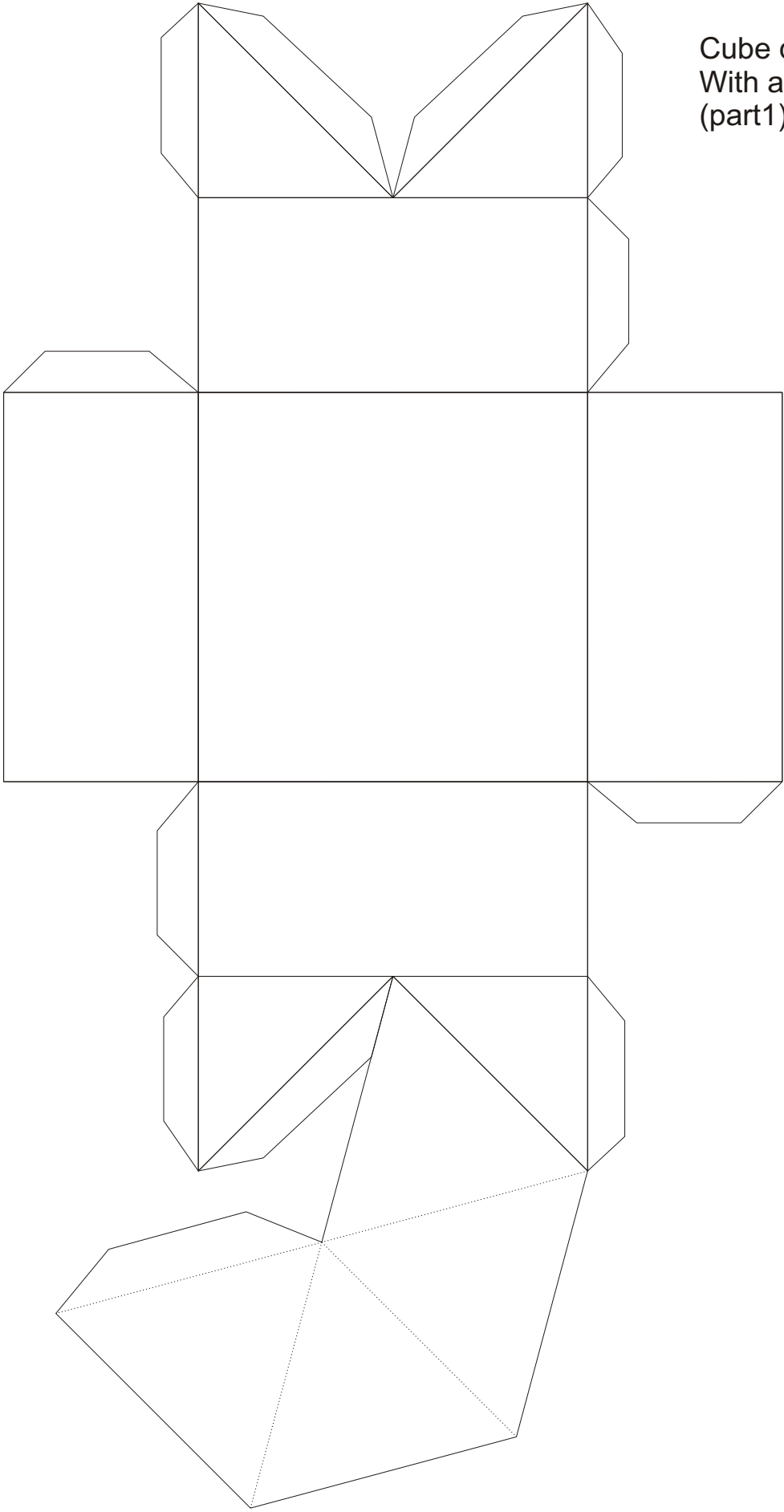

Cube divide in two parts
With a octhadron inside
(part1)

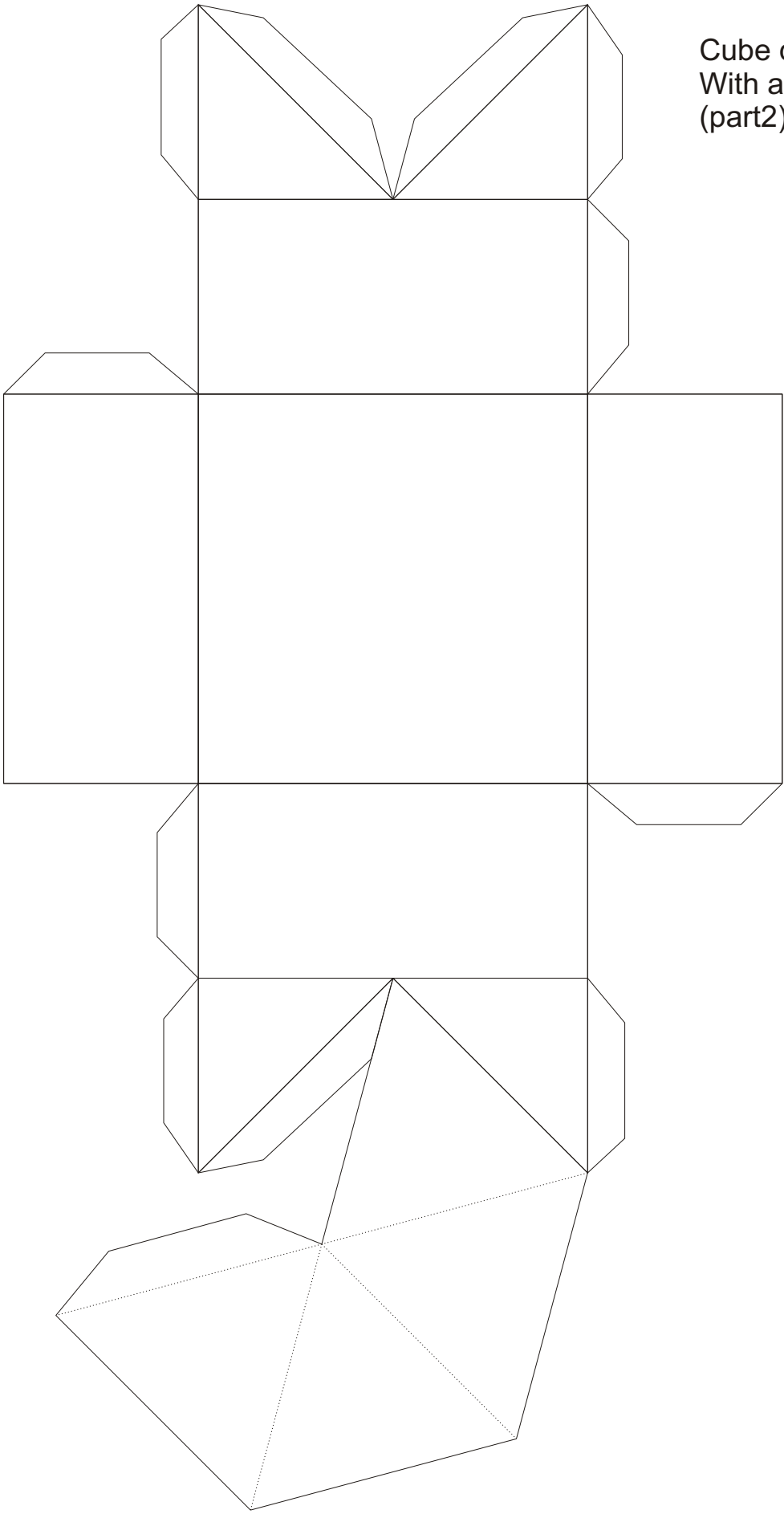

Cube divide in two parts
With a octhadron inside
(part2)

Octahedron:

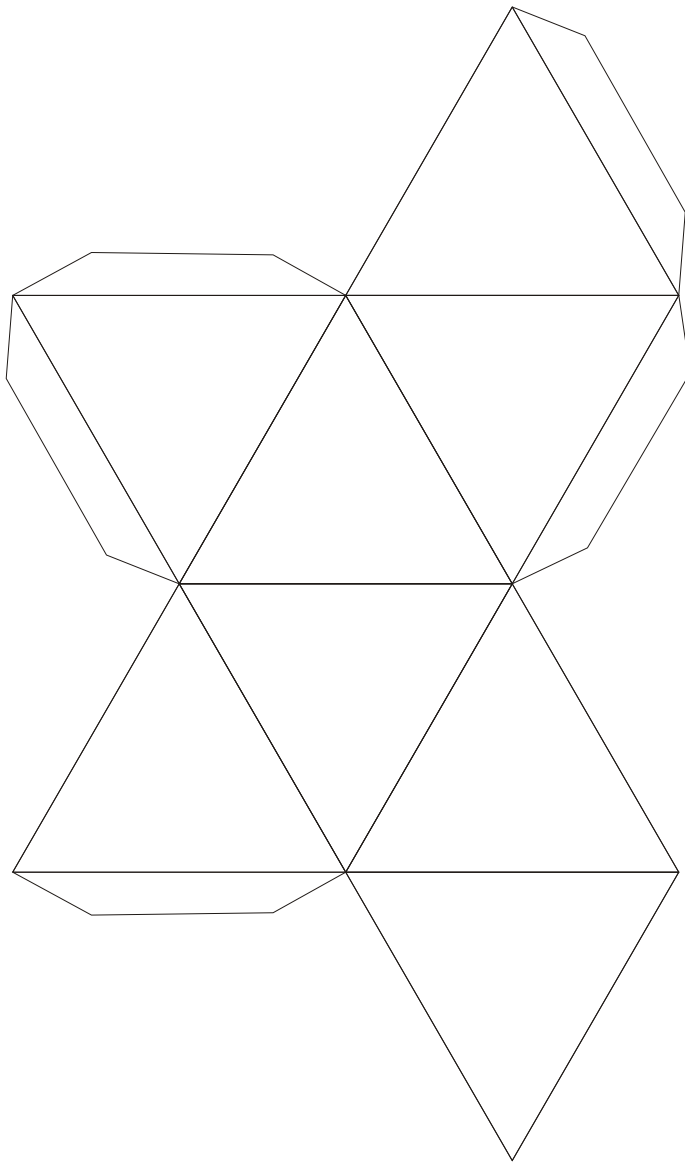

Octahedron with
Cube inside
(part 1)

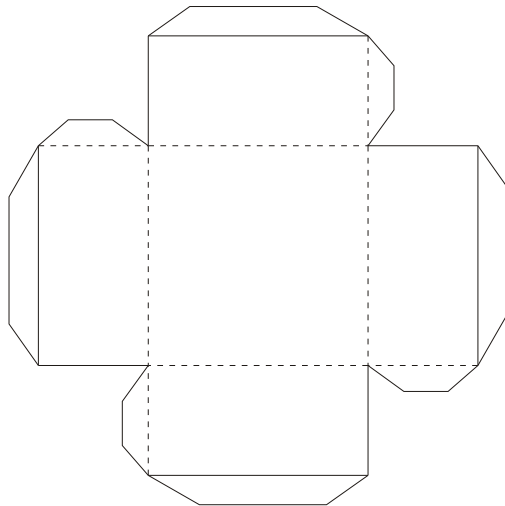
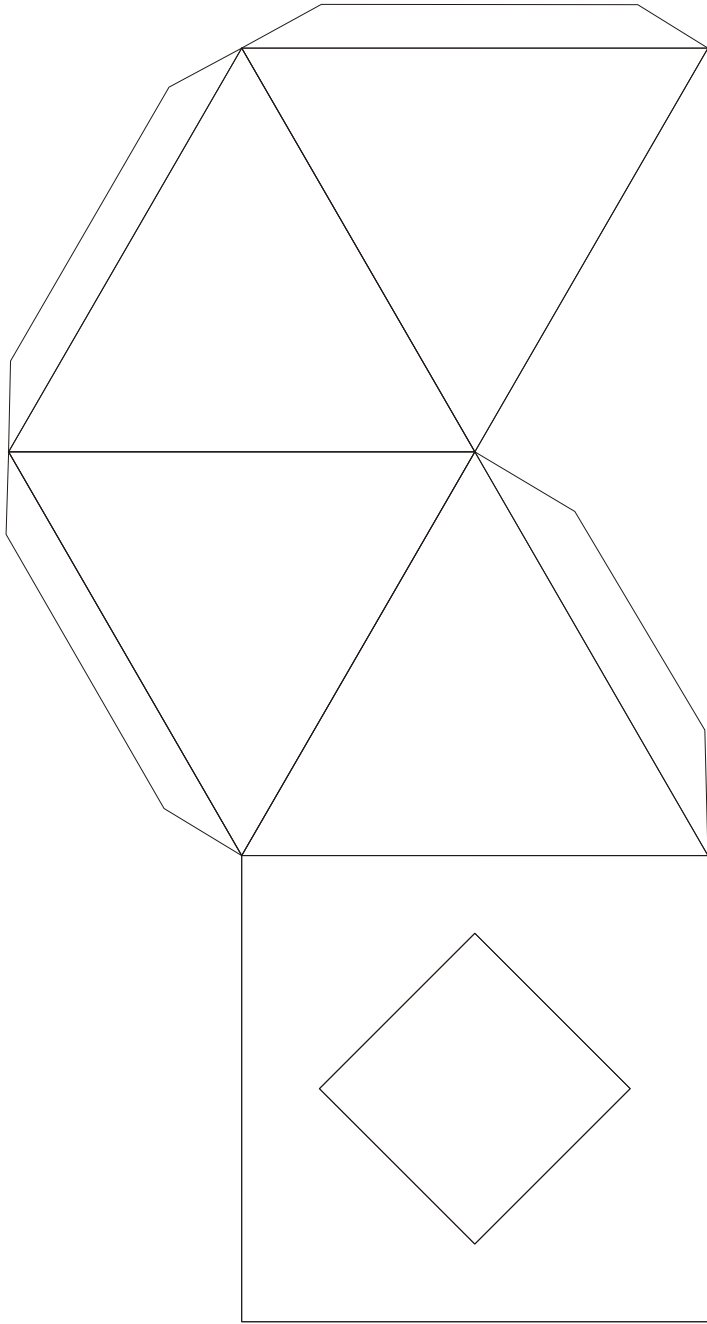

Octahedron with
Cube inside
(part 2)

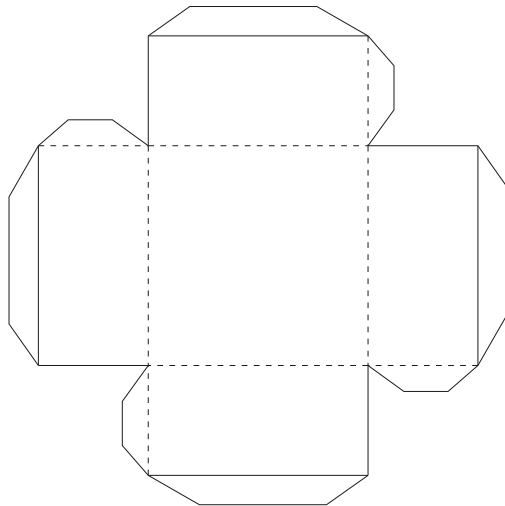
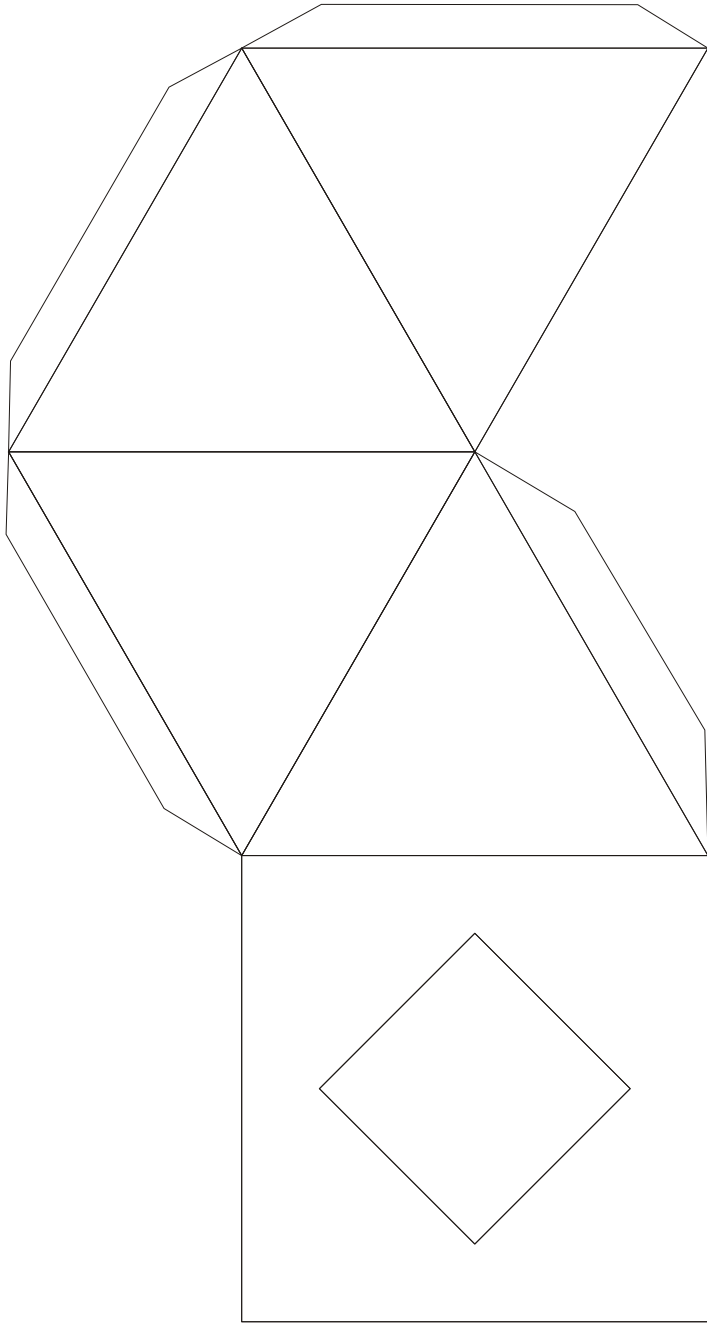

Octahedron with
Cube inside
(Cube)

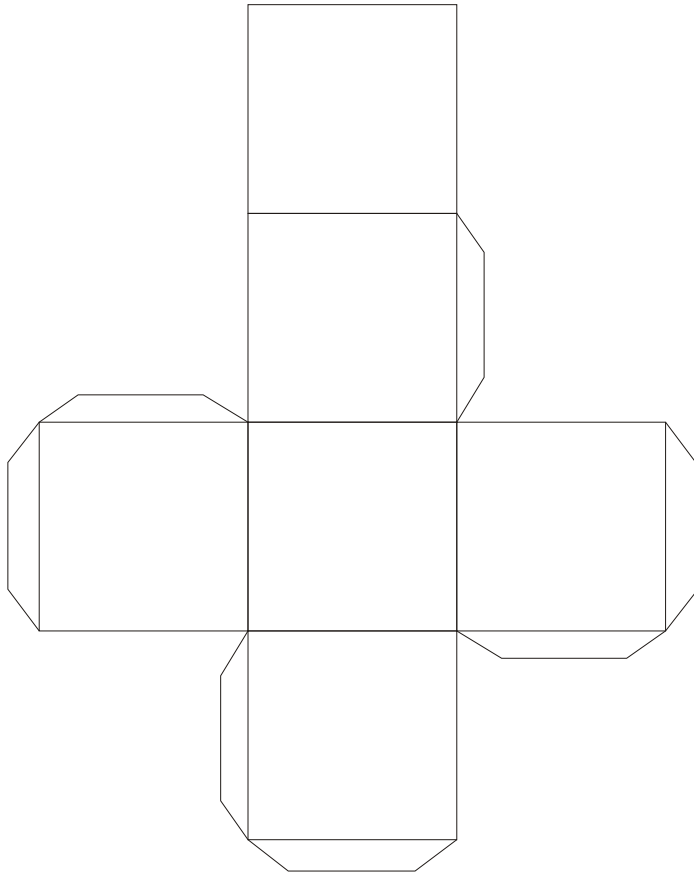

Icosahedron with Dodecahedron inside(part 1)

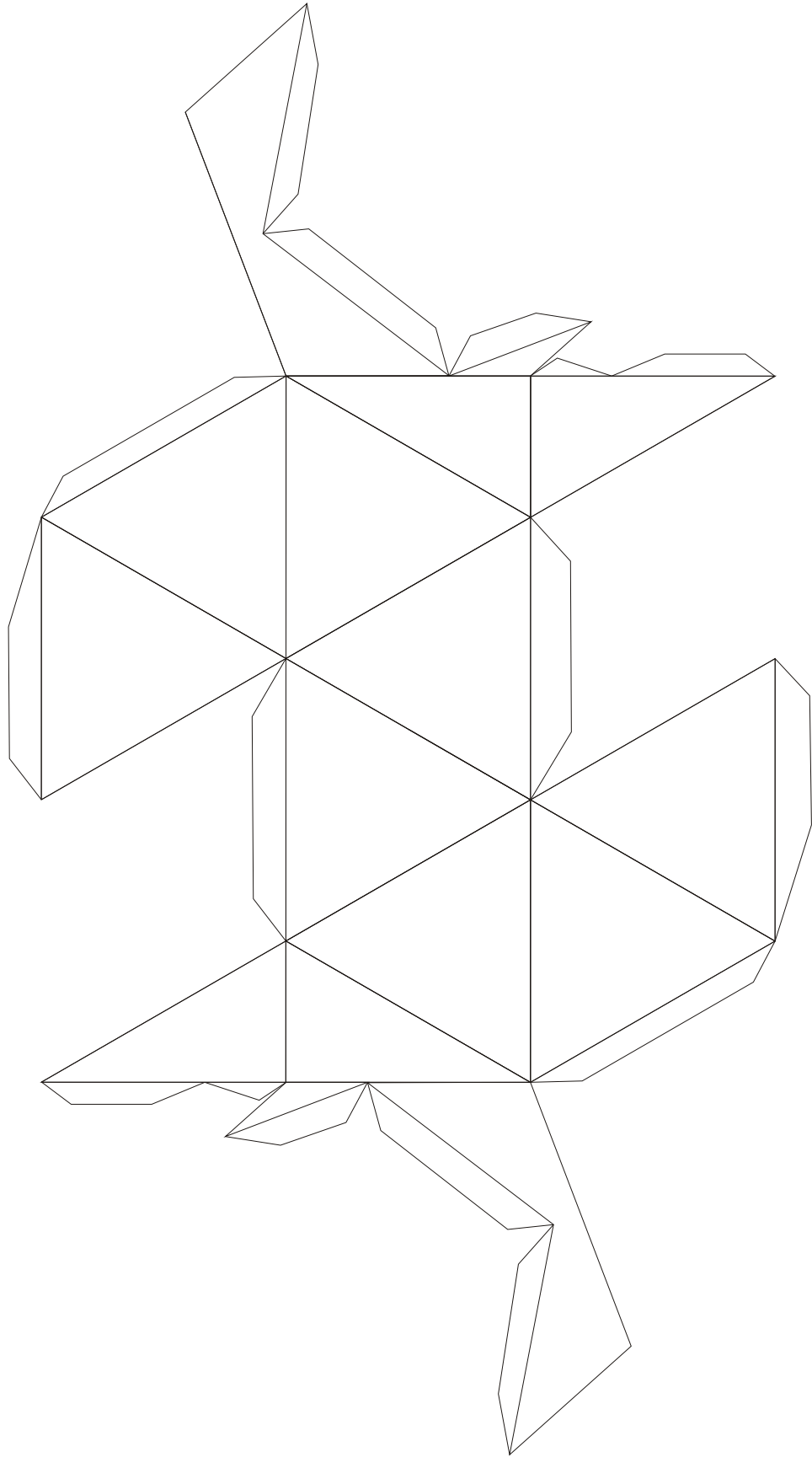

Icosahedron with Dodecahedron inside(part 2)

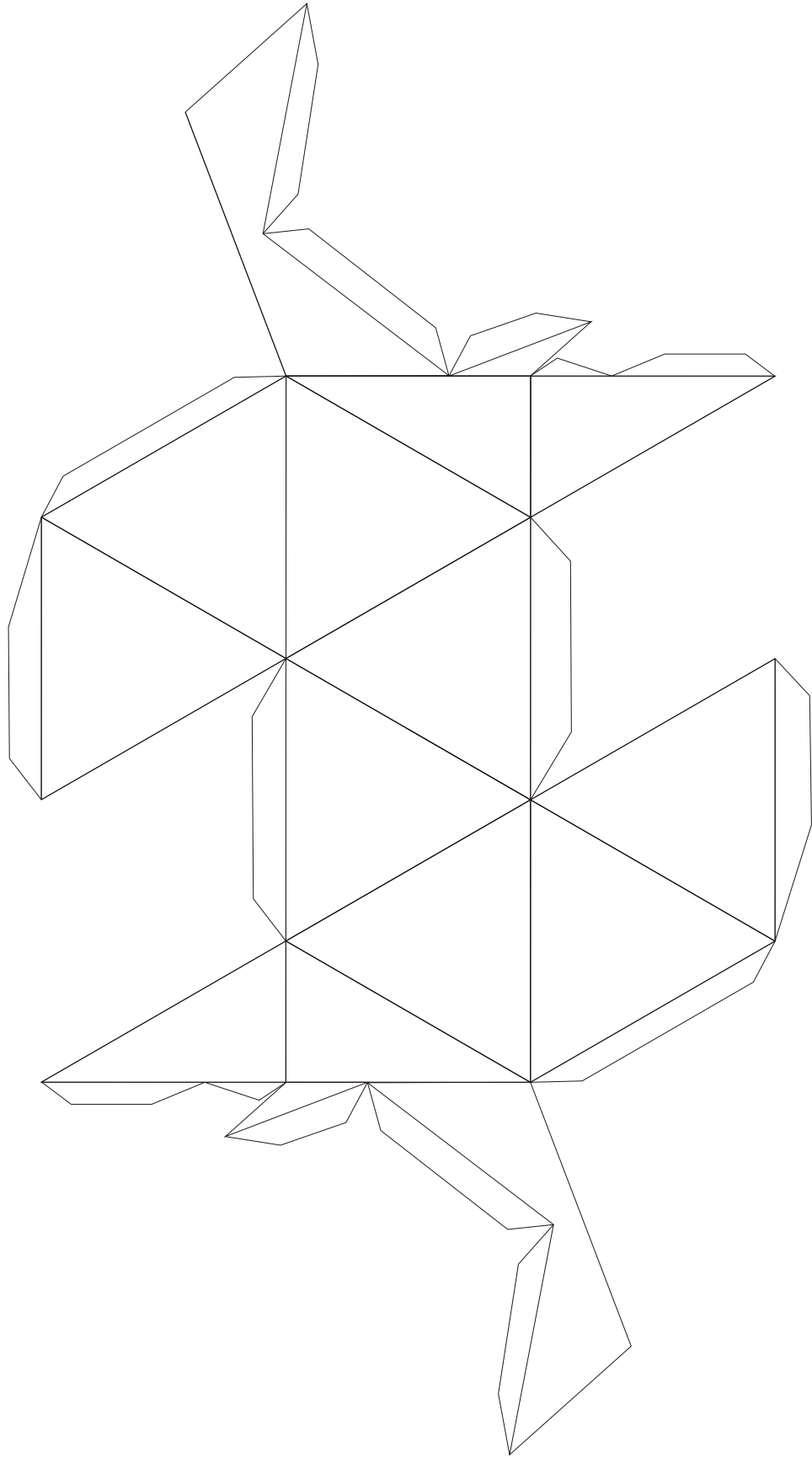

Icosahedron with Dodecahedron inside(part 3 and 4: interior of the icosahedron)

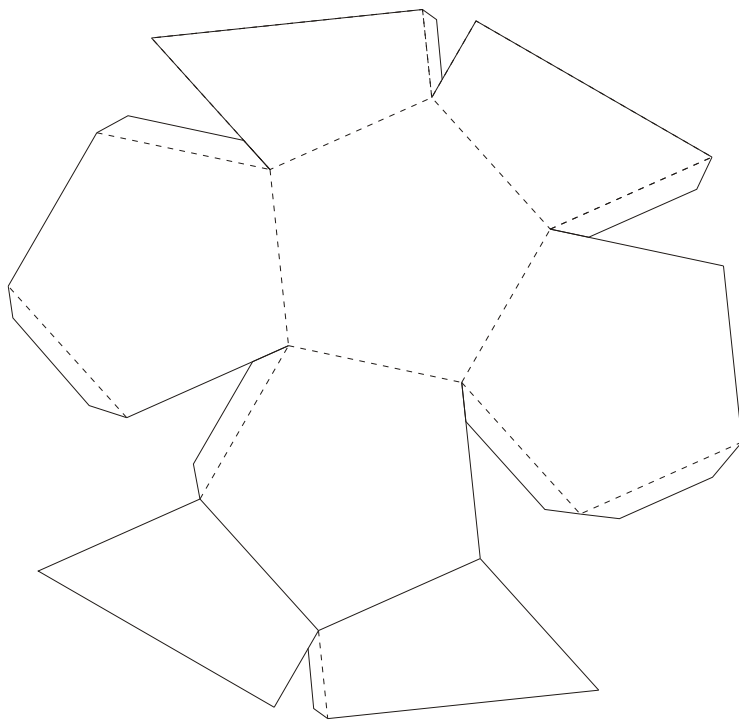
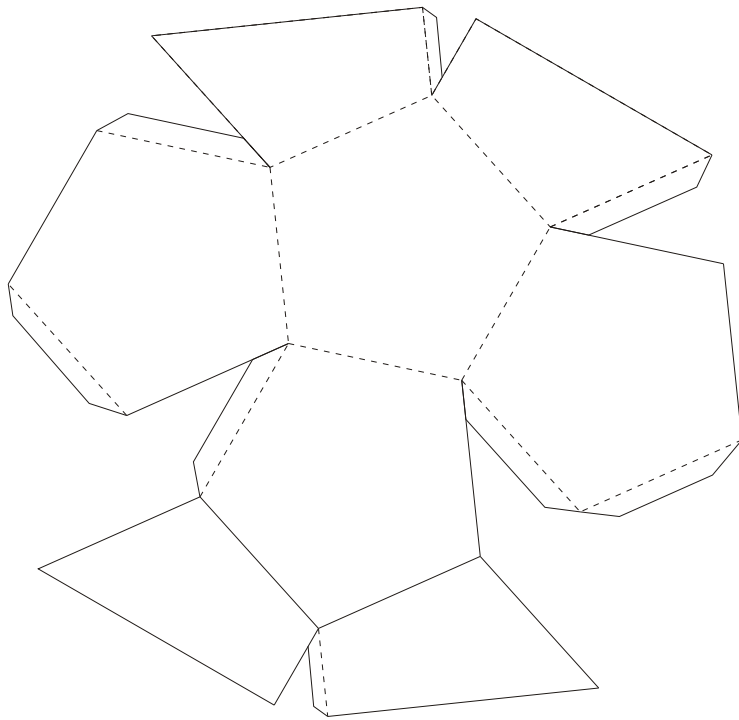

Dodecahedron

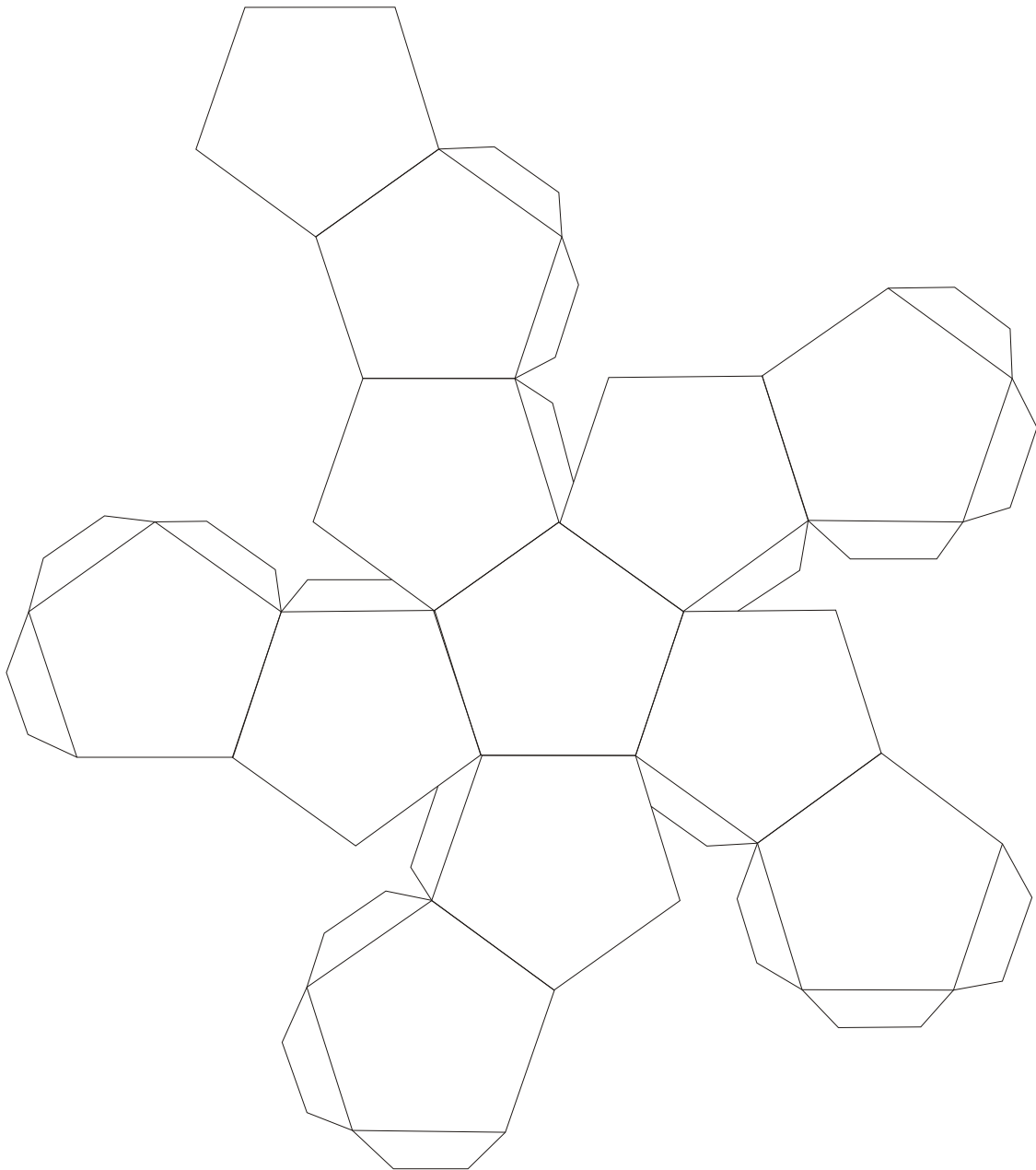

Tetrahedron in two parts
with a Tetrahedron inside (part 1 and a Tetrahedron)

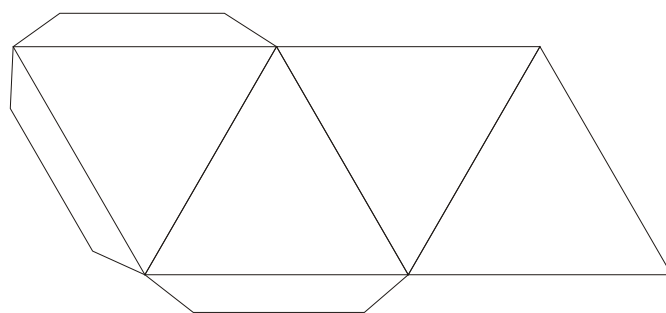
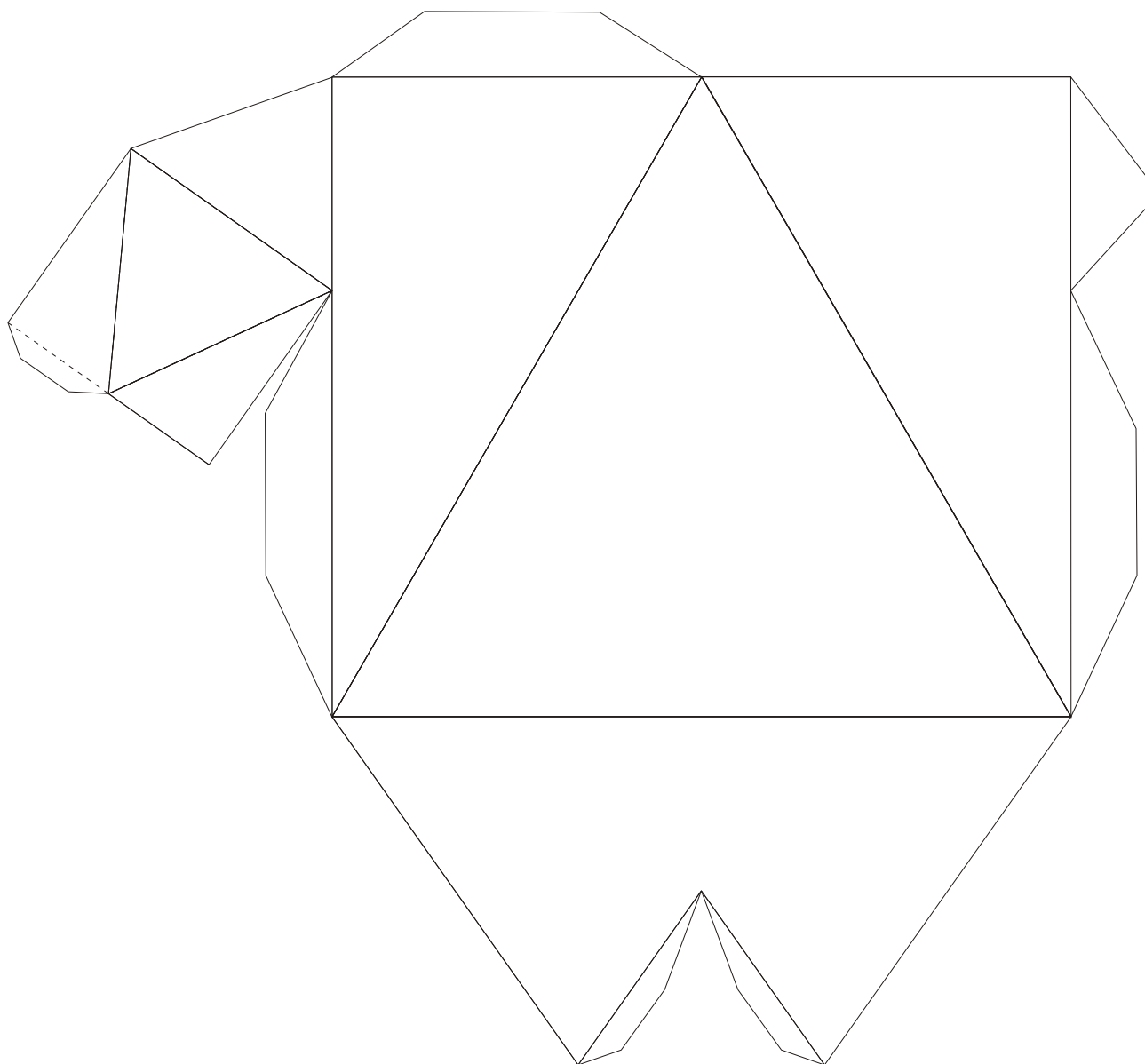

Tetrahedron in two parts
with a Tetrahedron inside (part 2)

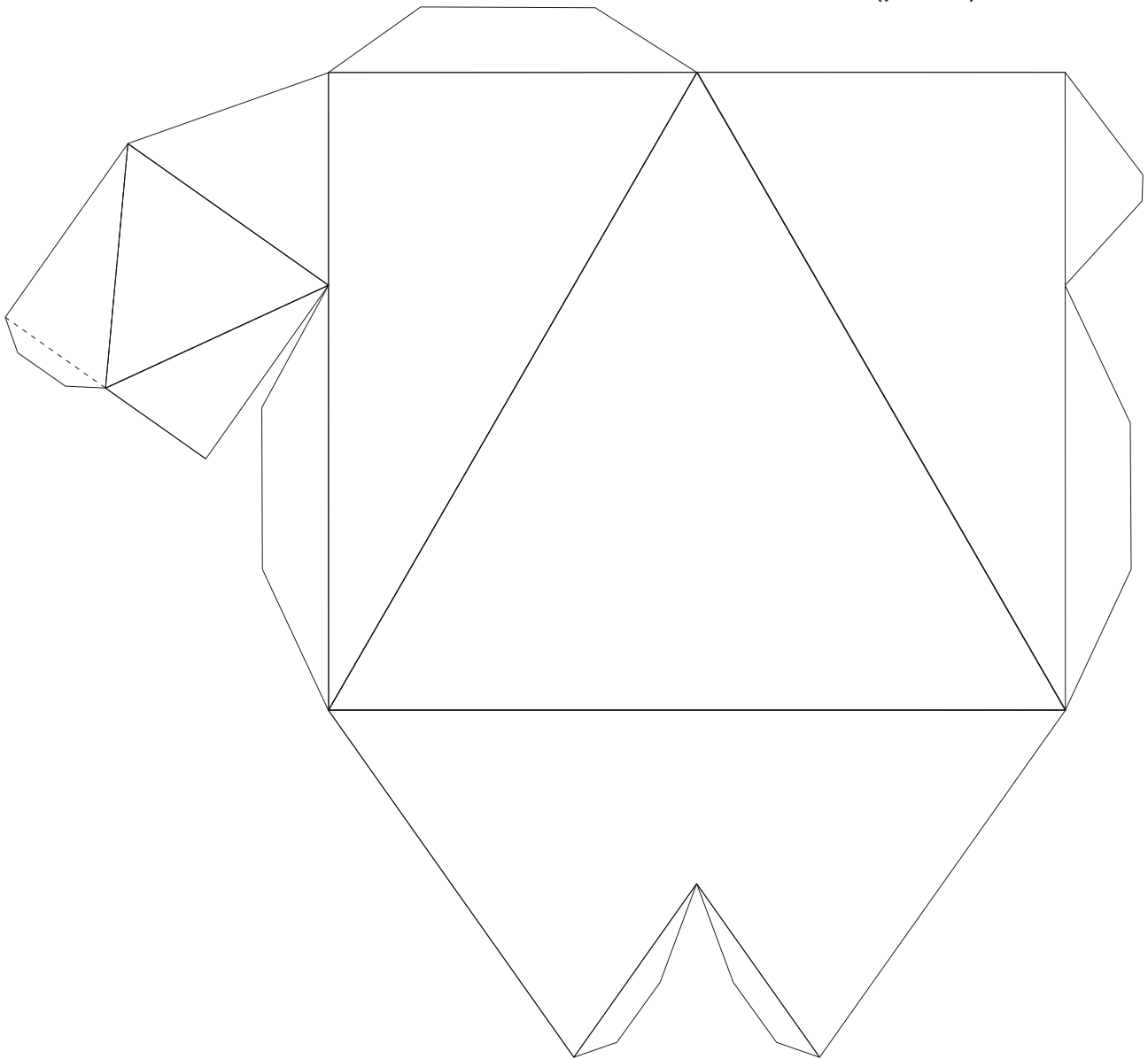

Dodecahedron divided in two parts
with a Cube inside (part 1)

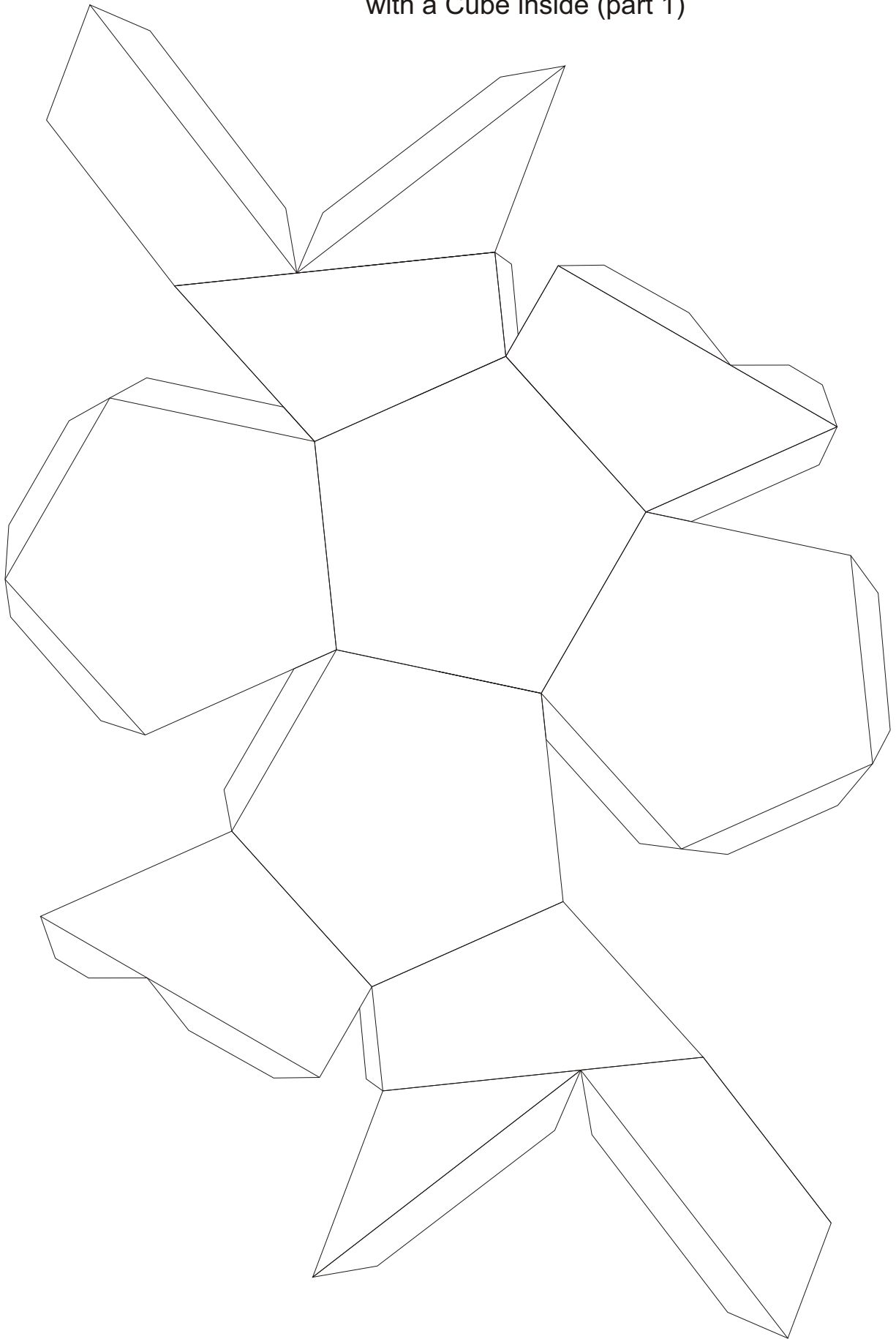

Dodecahedron divided in two parts
with a Cube inside (part 2)

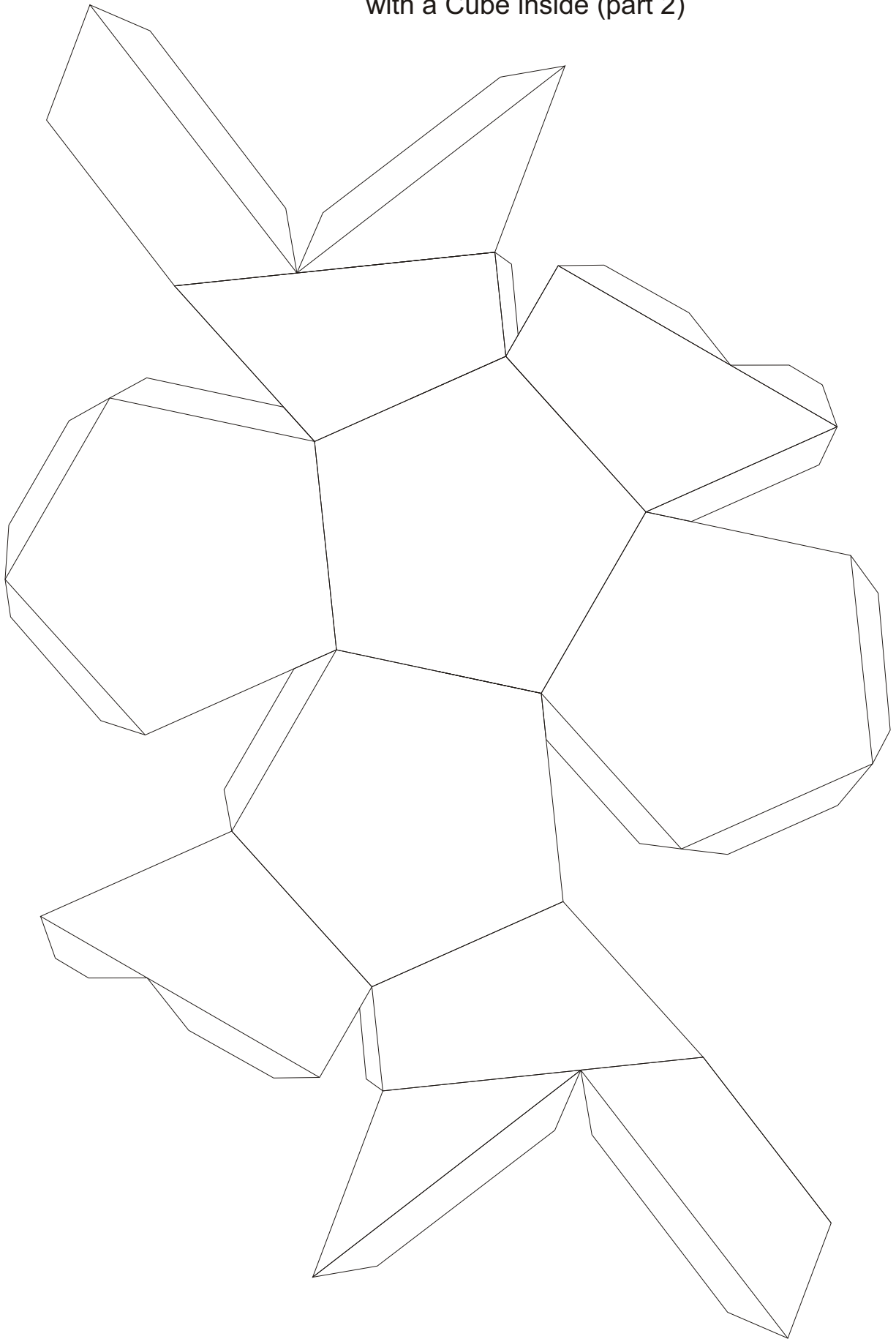

Dodecahedron divided in two parts
with a Cube inside (part 3 and 4))

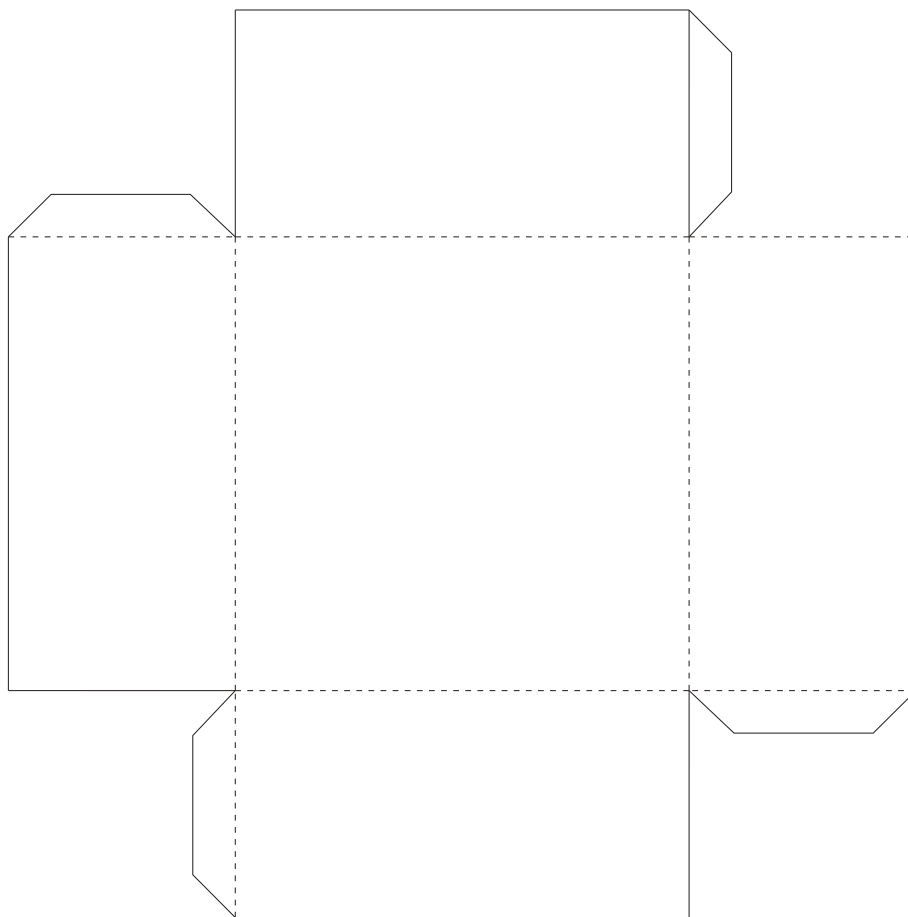
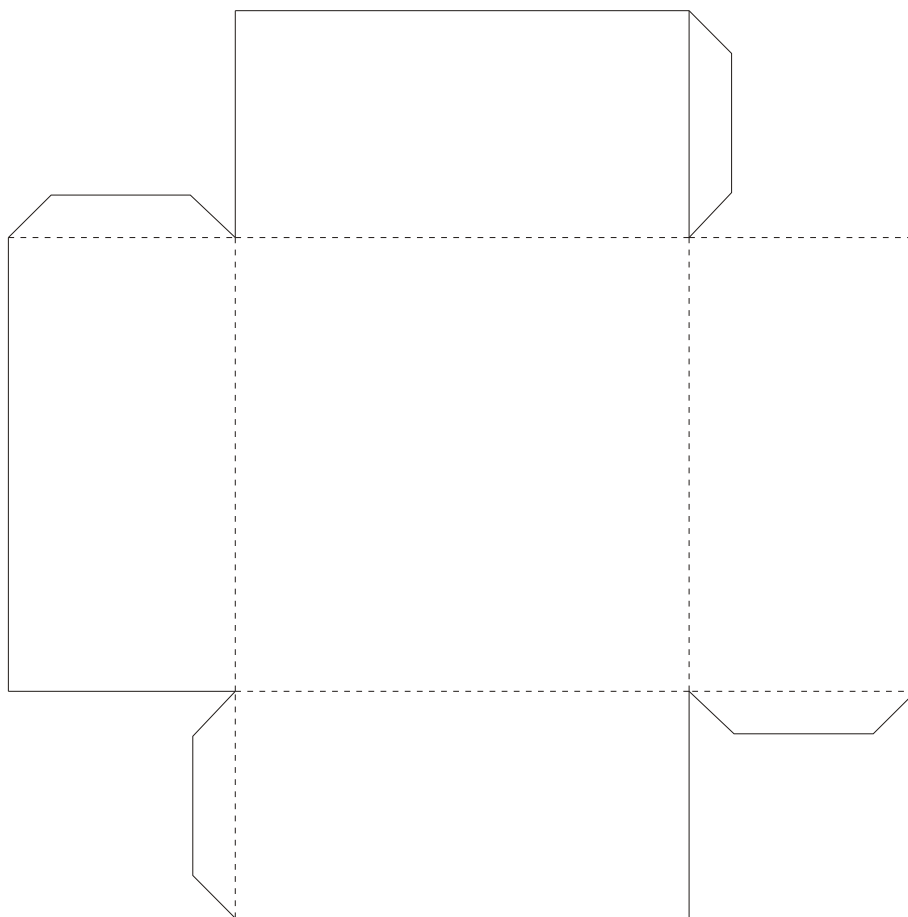

Dodecahedron divided in two parts
with a Cube inside (cube))

