

Truncated Octahedron

Print the model on five
different colored papers
(each color 2 pages)

Color 1

1. Start with part 1 and glue part 2 on the tab of part 1 with the number 2.
 2. Glue part 3 on the parts 1 and 2 on the tab(s) with the number 3.
 3. Glue part 4 on the parts 1, 2 and 3 on the tab(s) with the number 4.
- Etc.

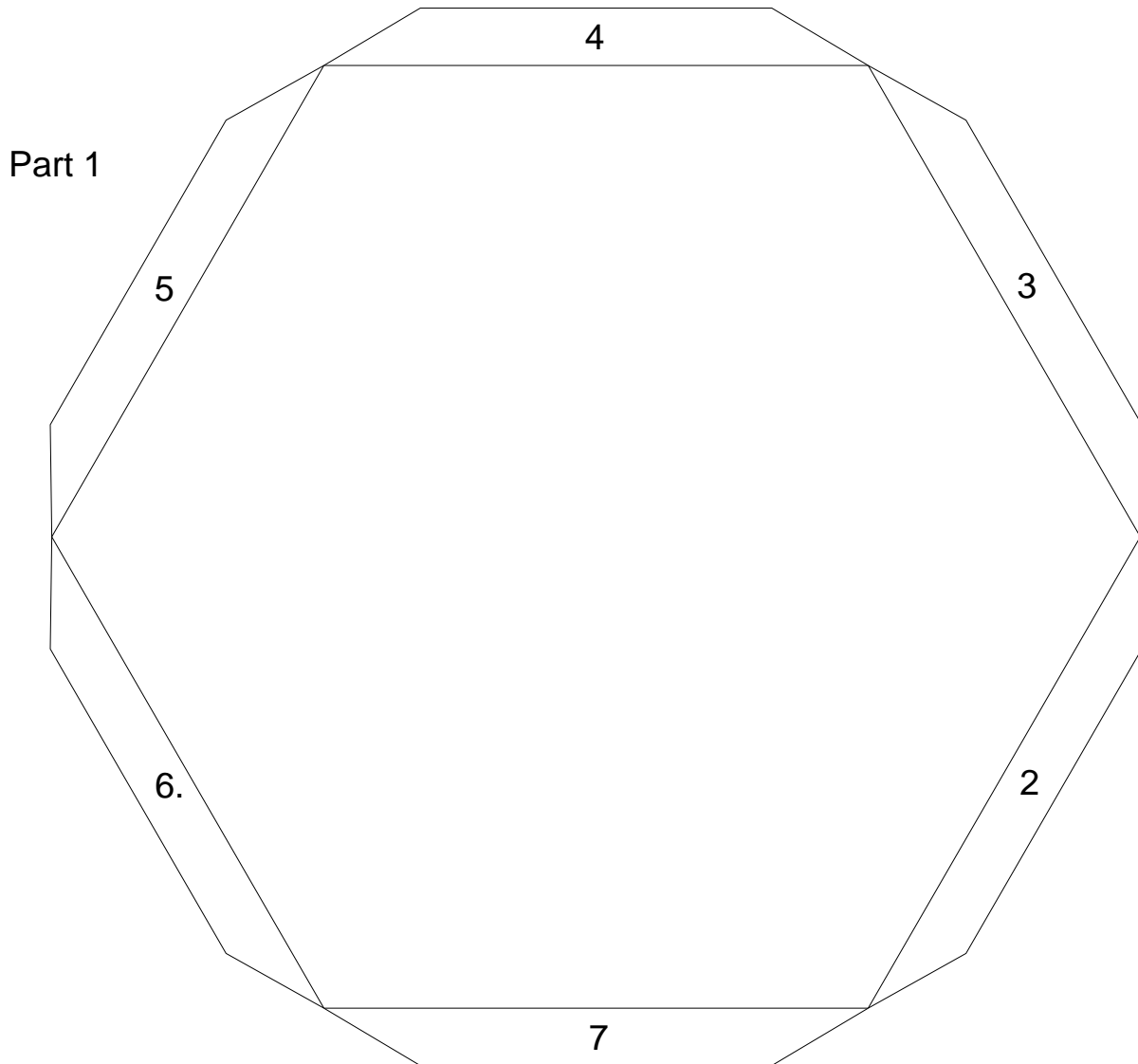

Truncated Octahedron

Color 1

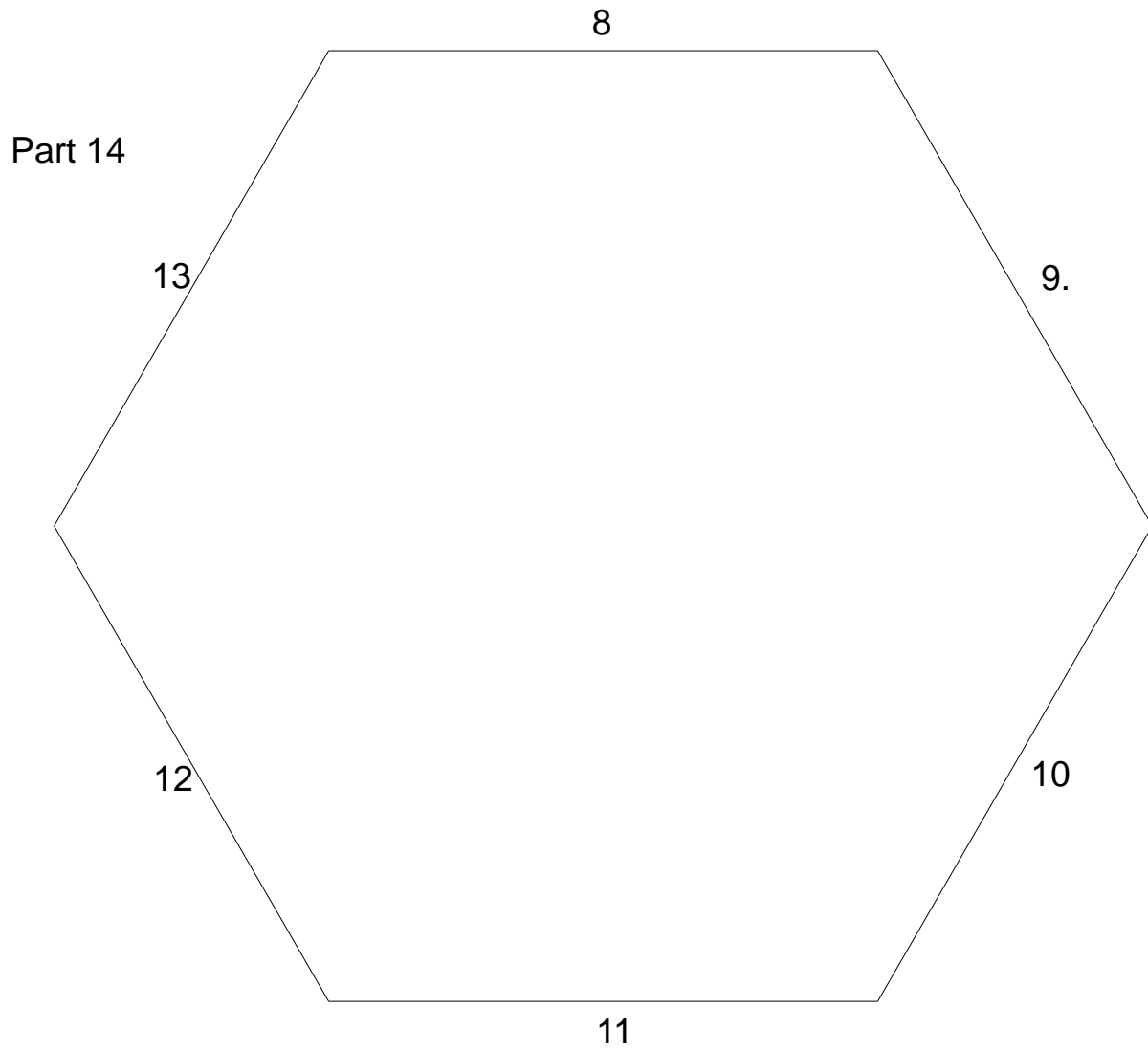

Truncated Octahedron

Color 2

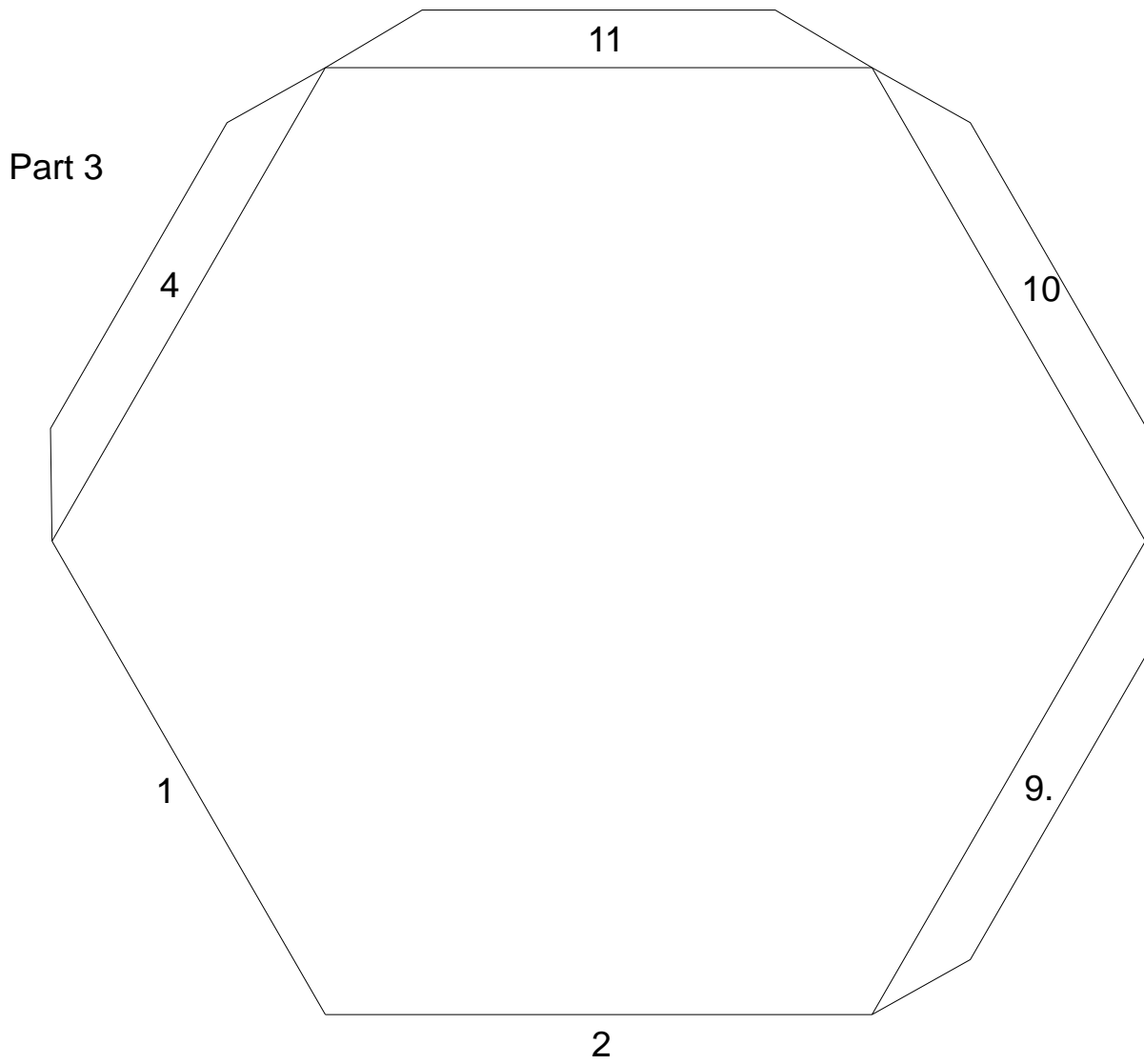

Truncated Octahedron

Color 2

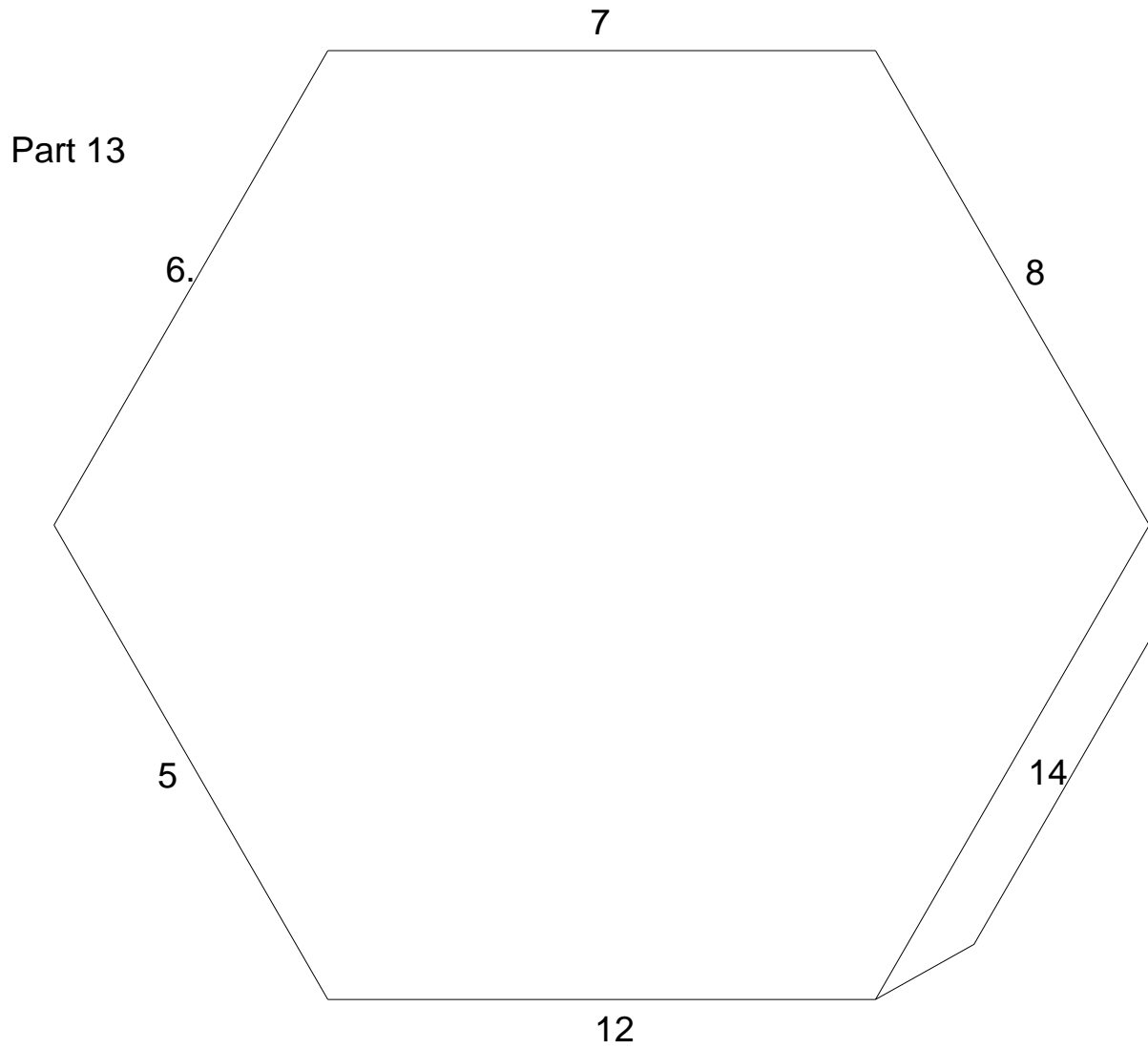

Truncated Octahedron

Color 3

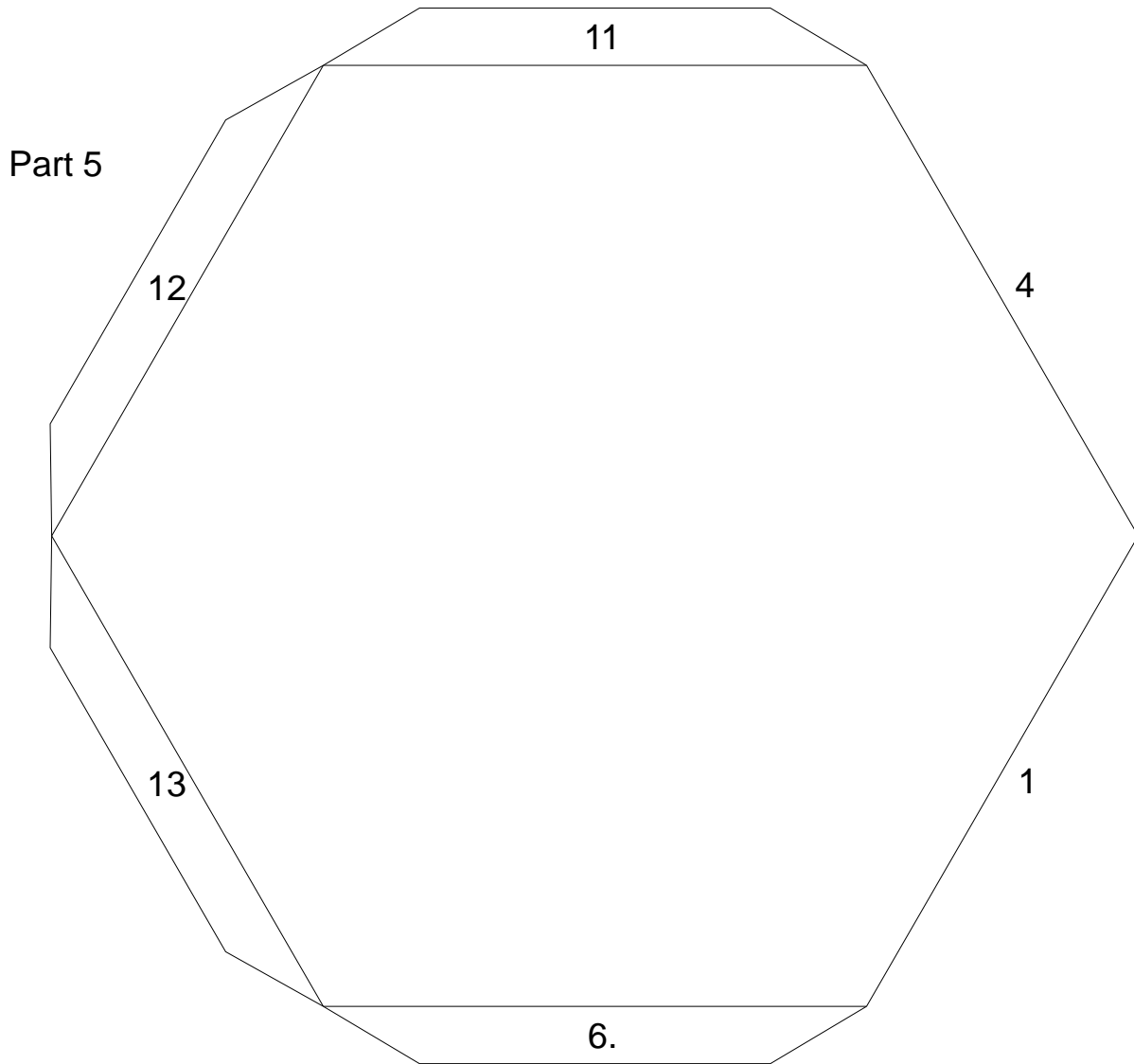

Truncated Octahedron

Color 3

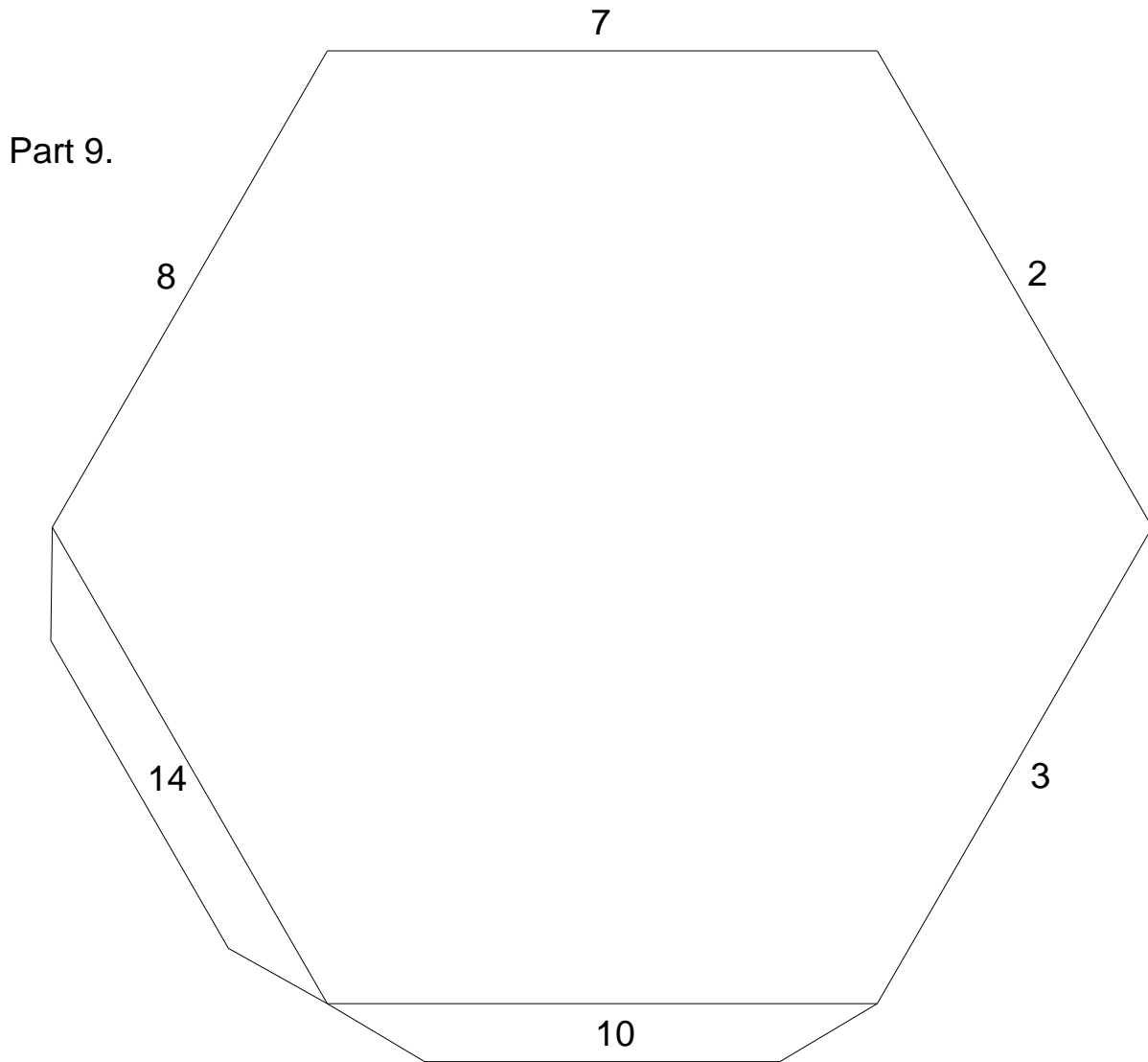

Truncated Octahedron

Color 4

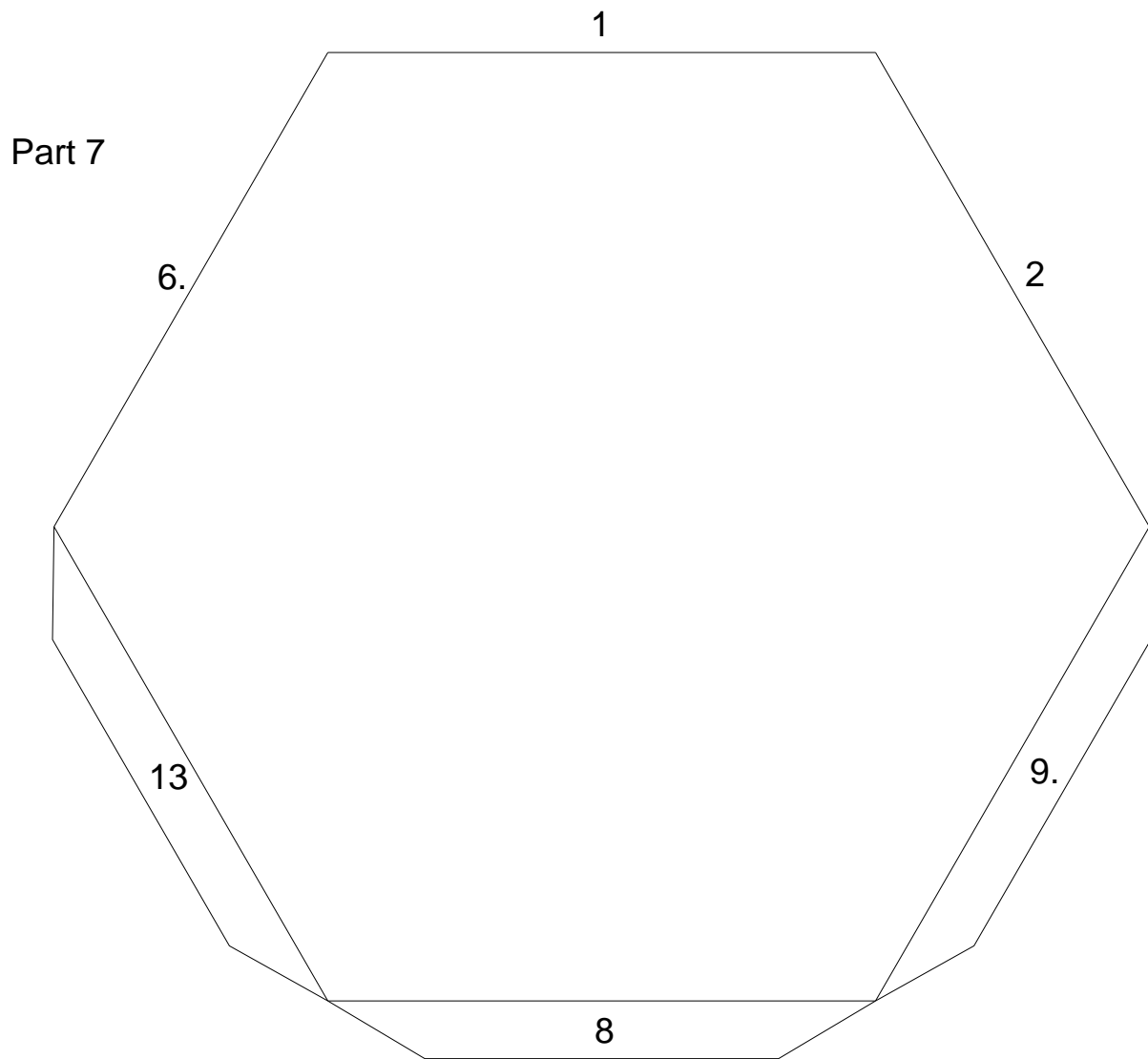

Truncated Octahedron

Color 4

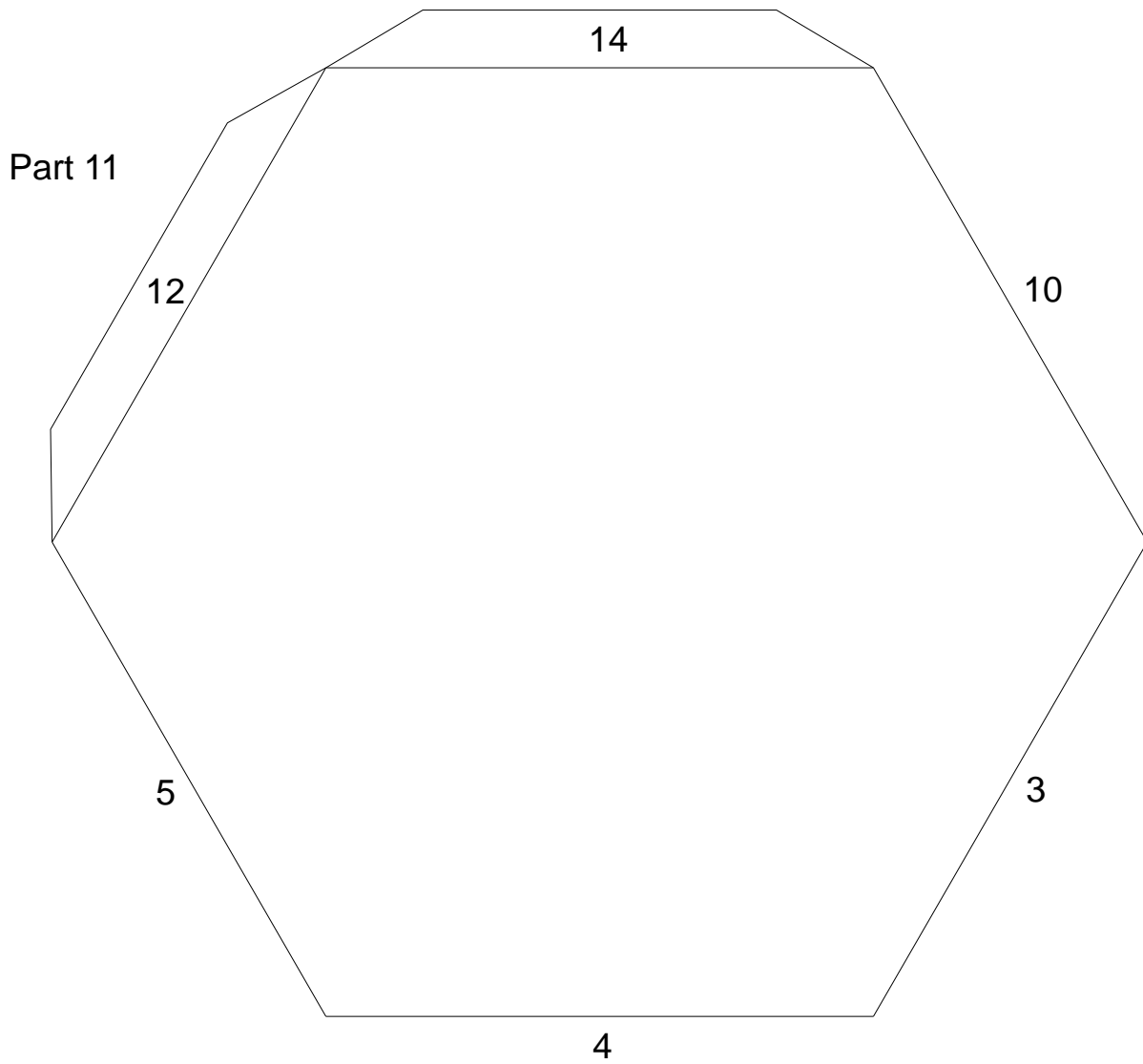

Truncated Octahedron

Color 5

Part 2

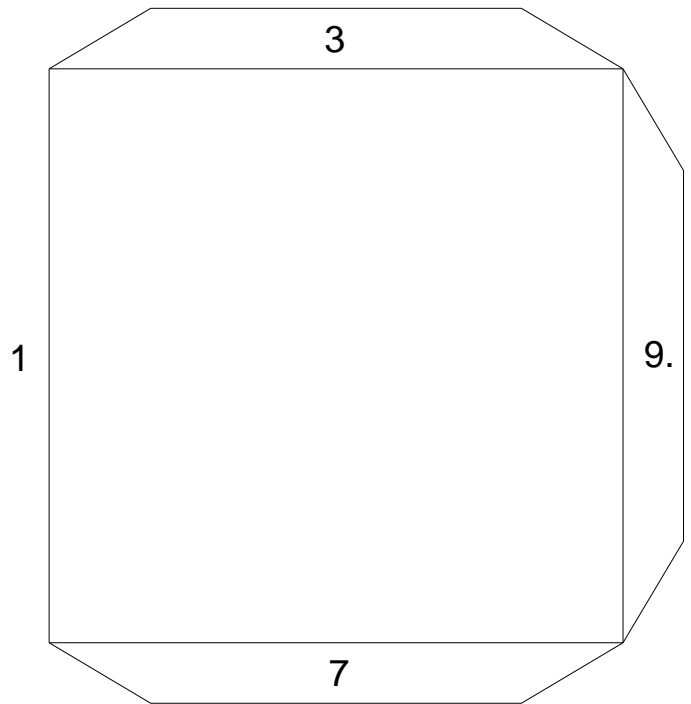

Part 4

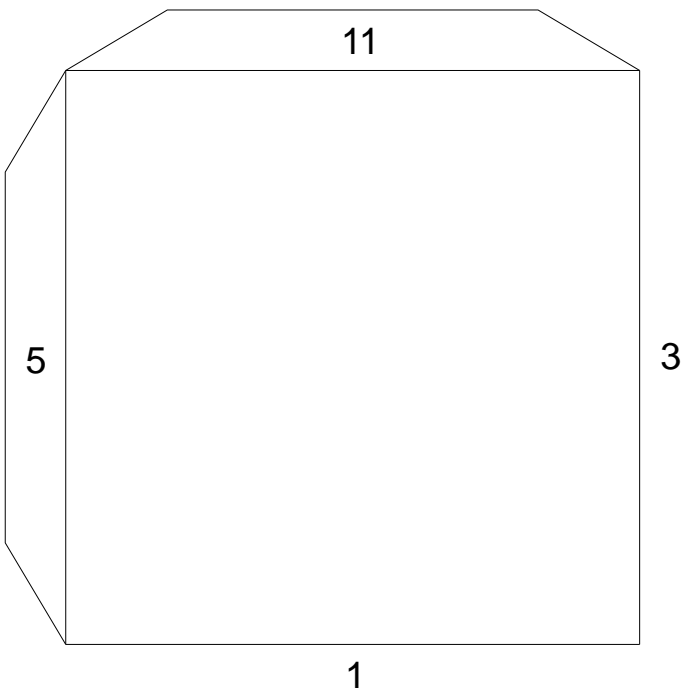

Part 6.

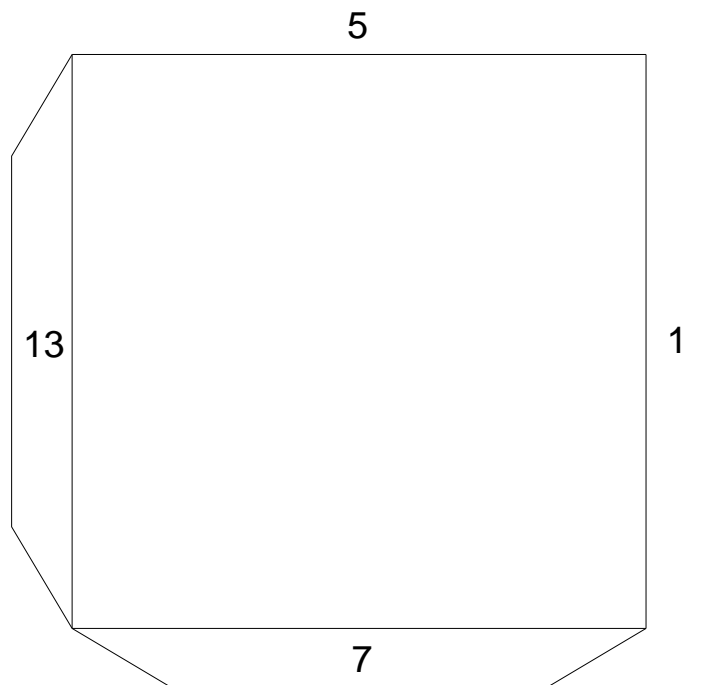

Truncated Octahedron

Part 8

7

Color 5

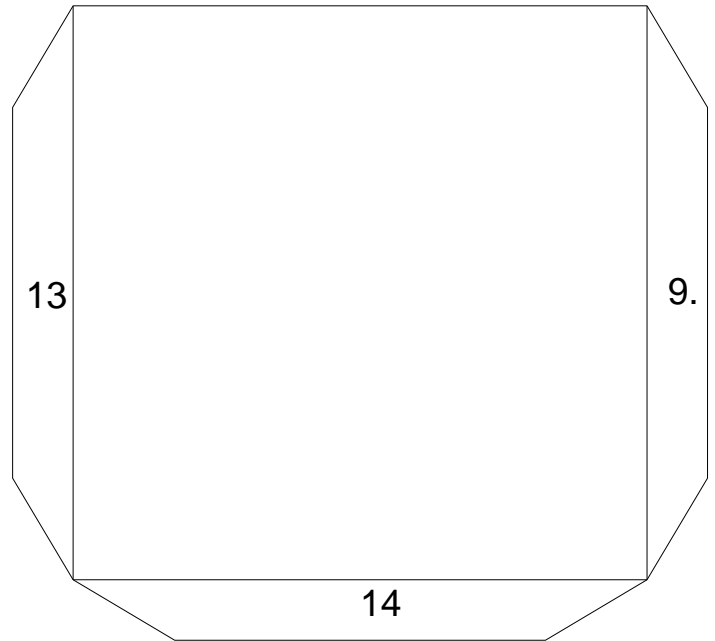

Part 10

9.

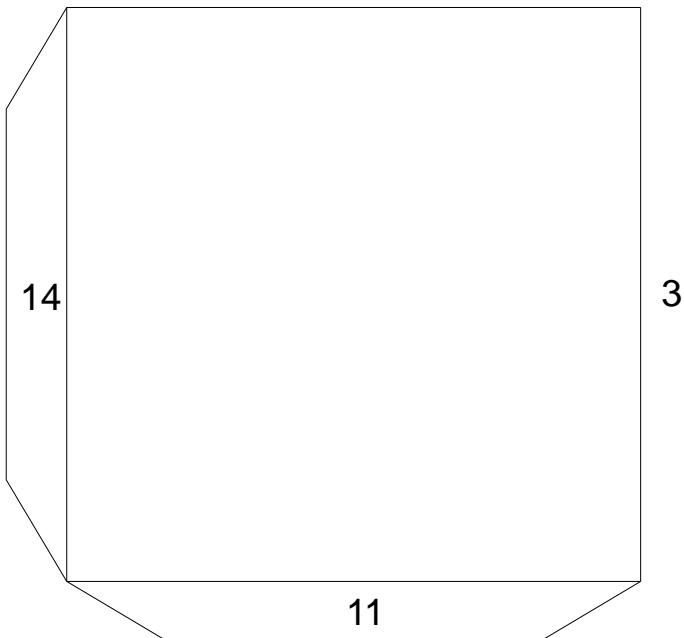

Part 12

14

