

Snub Cube (left-handed)

Print the model on five
different colored papers

Color 1: three pages

Color 2, 3, 4 and 5 : two page.

Color 1

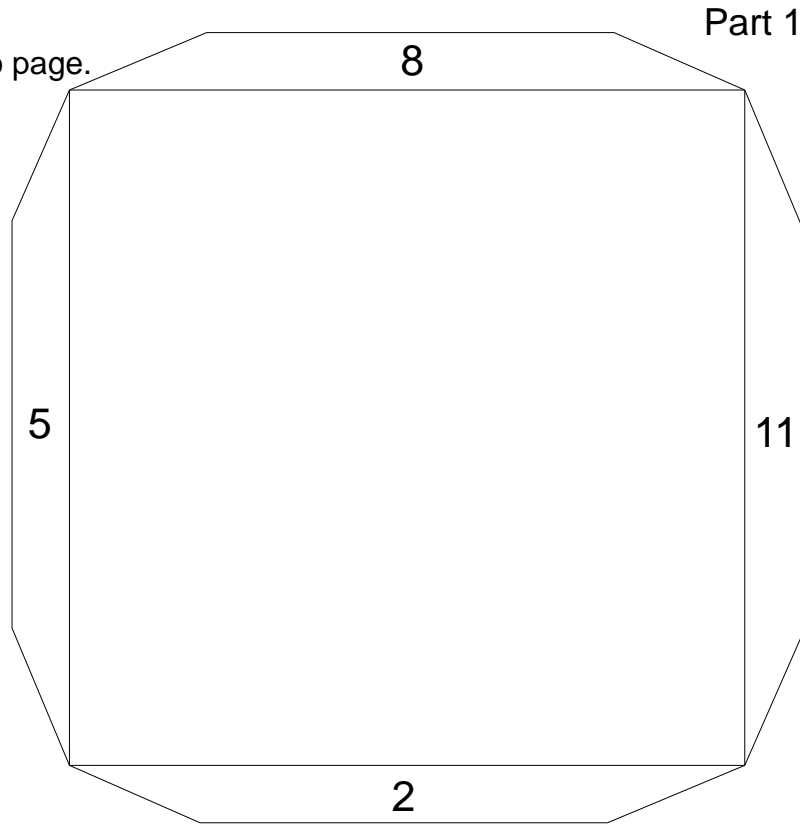

Part 14

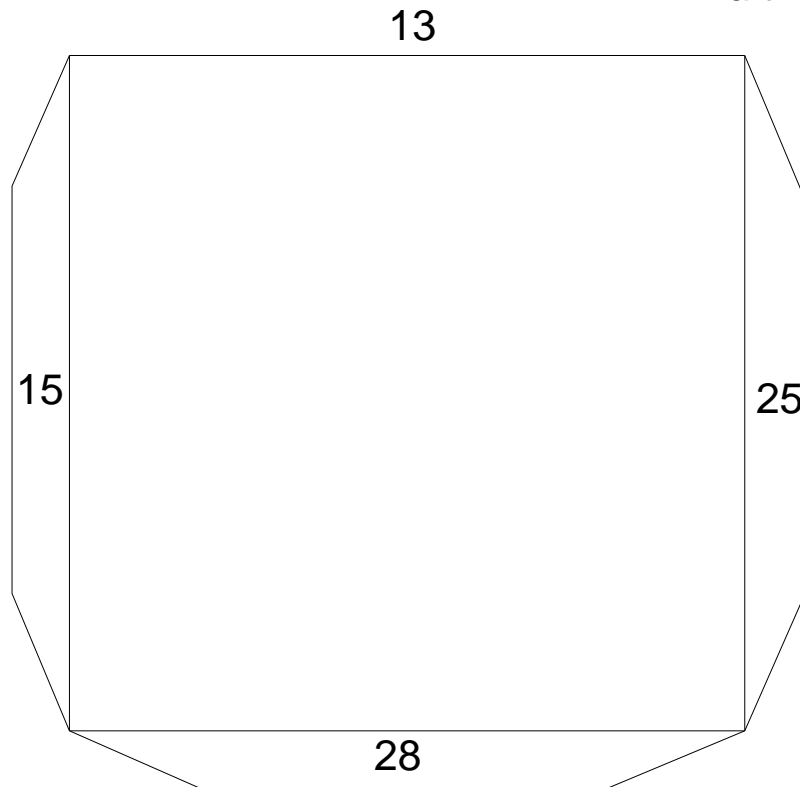

1. Start with part 1 and glue part 2 on the tab of part 1 with the number 2.
 2. Glue part 3 on the parts 1 and 2 on the tab(s) with the number 3.
 3. Glue part 4 on the parts 1, 2 and 3 on the tab(s) with the number 4.
- Etc.

Snub Cube (left-handed)

Color 1

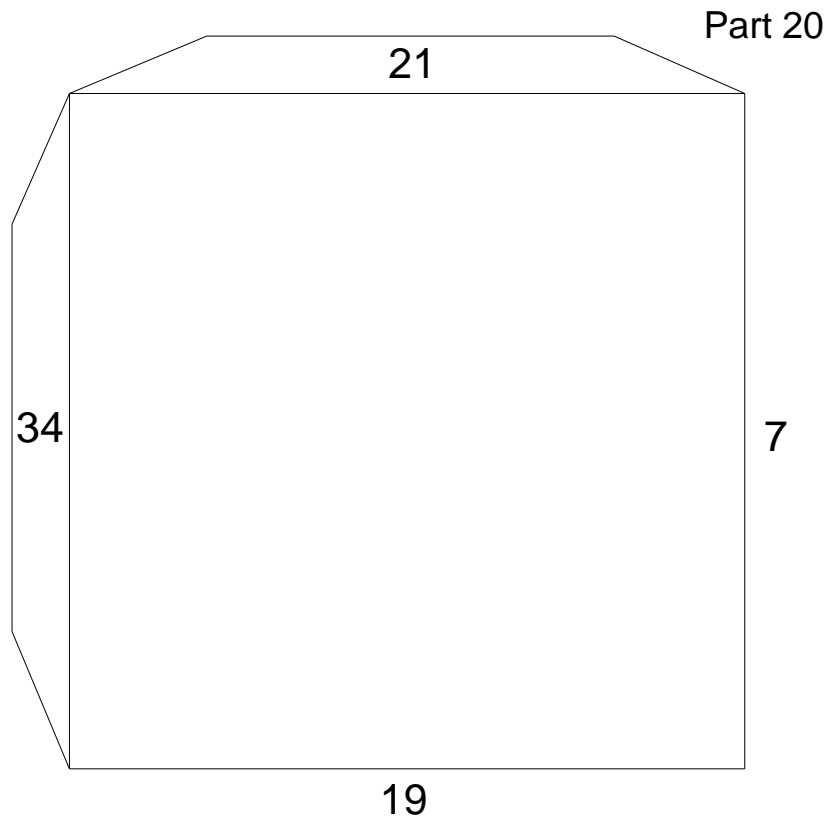
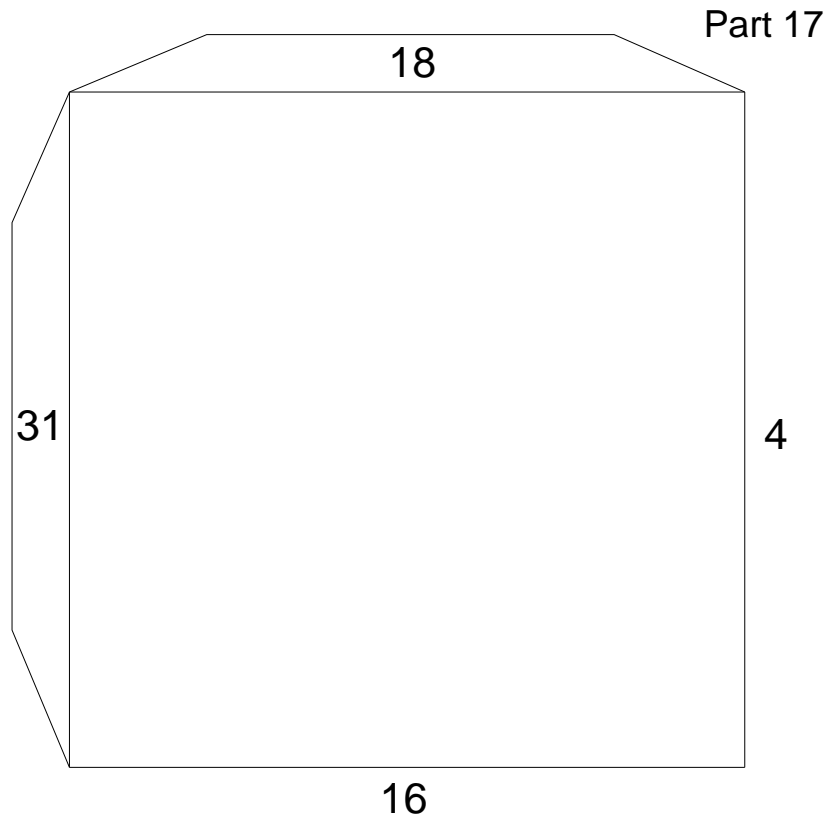

Snub Cube (left-handed)

Color 1

Part 23

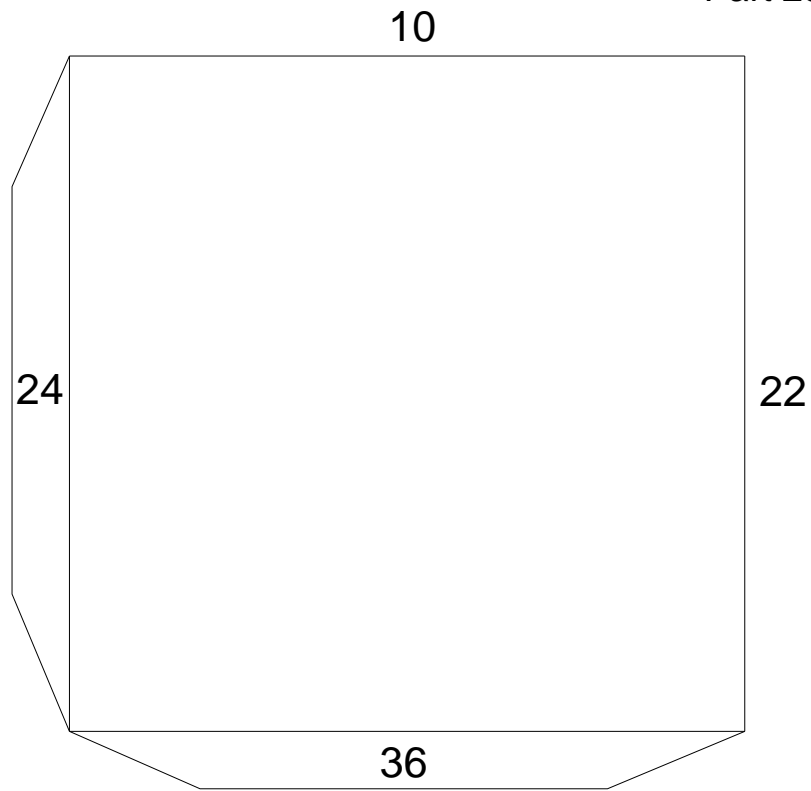

Part 38

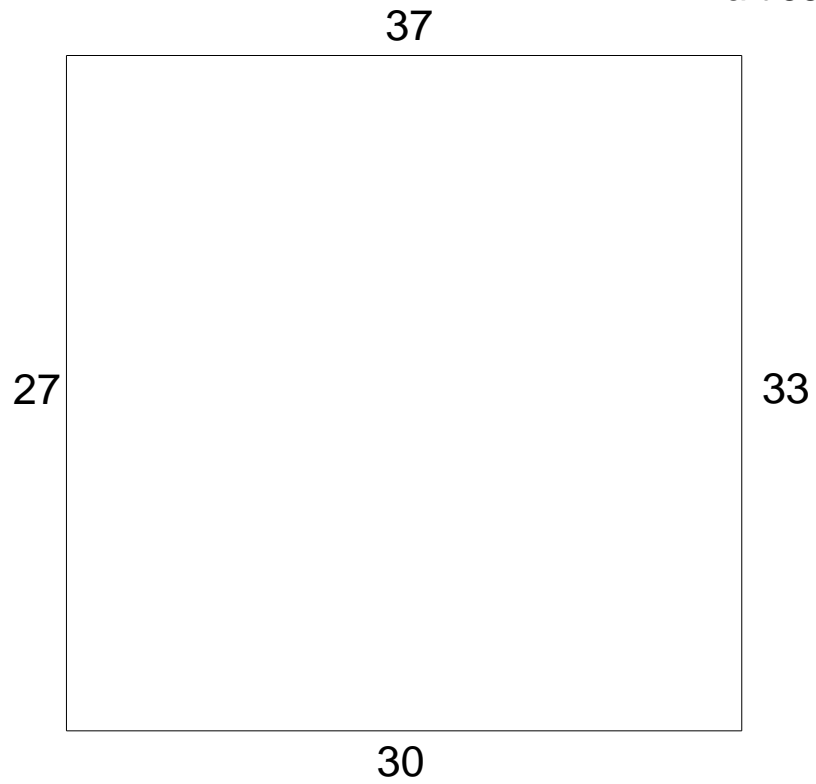

Snub Cube (left-handed)

Color 2

Part 2

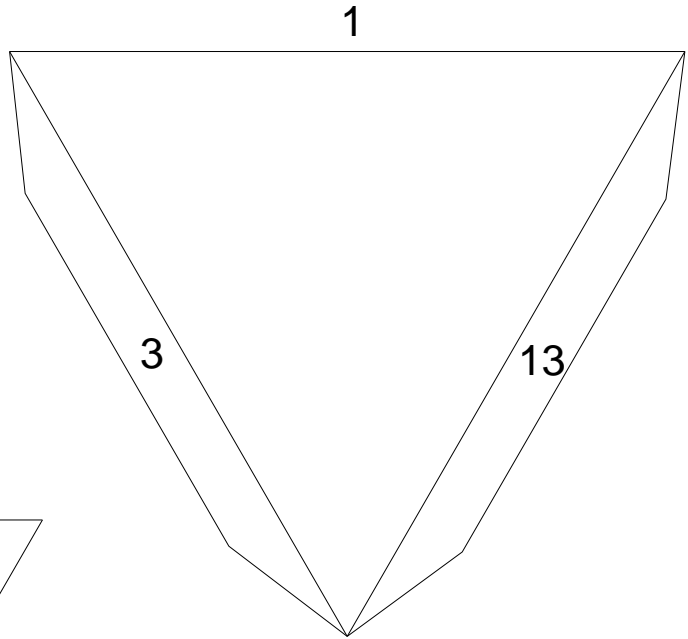

Part 5

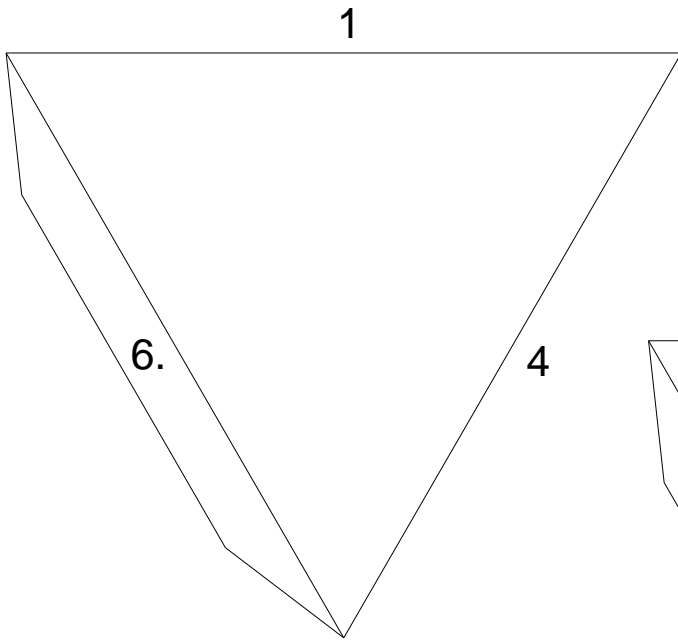

Part 8

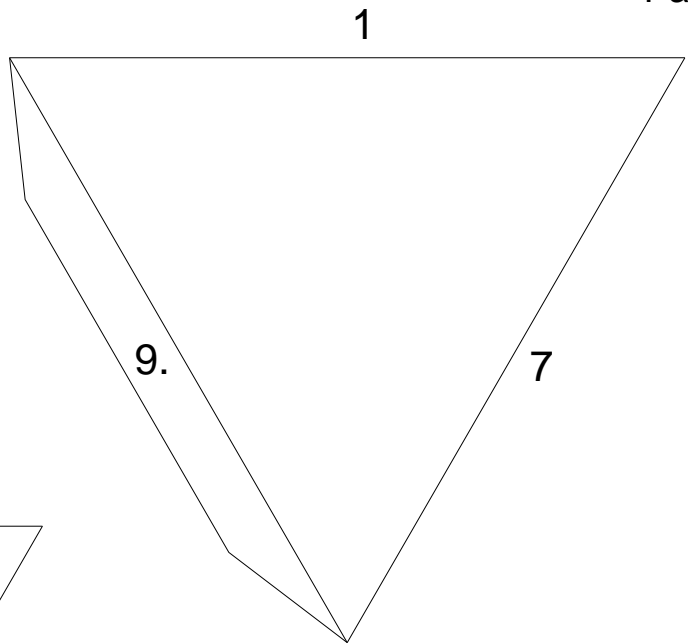

Part 11

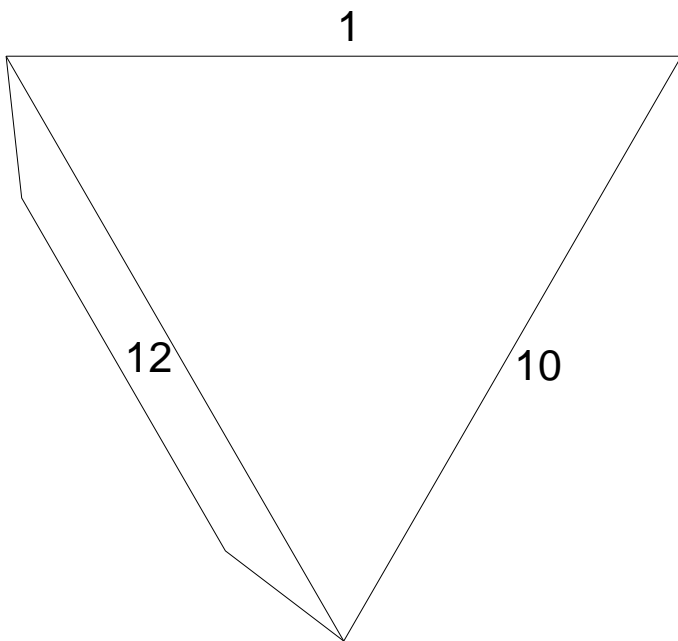

Snub Cube (left-handed)

Part 27

Color 2

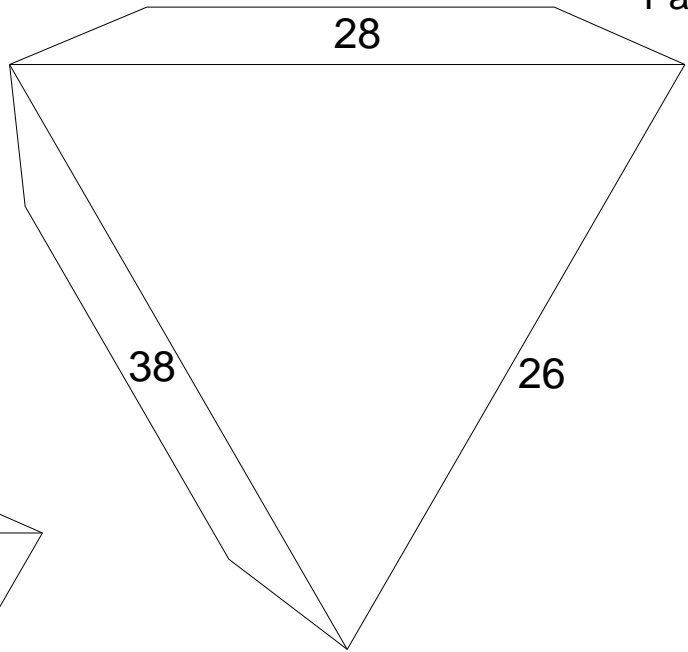

Part 30

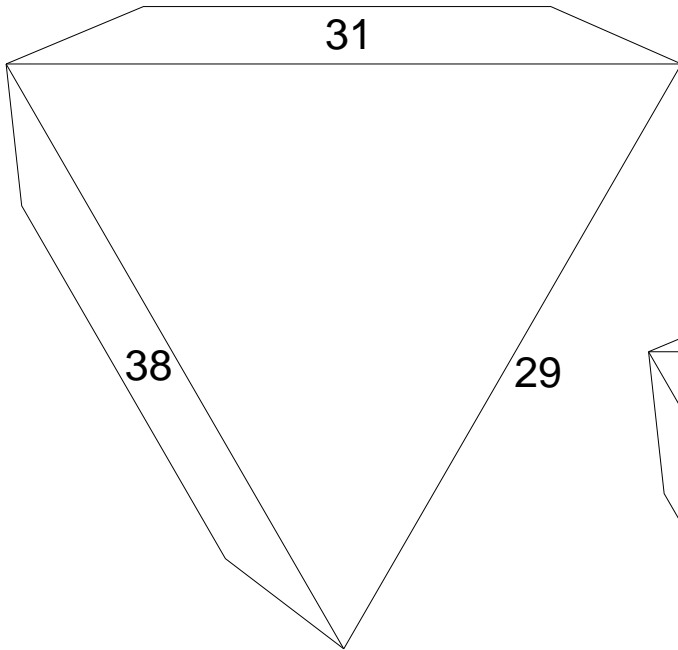

Part 33

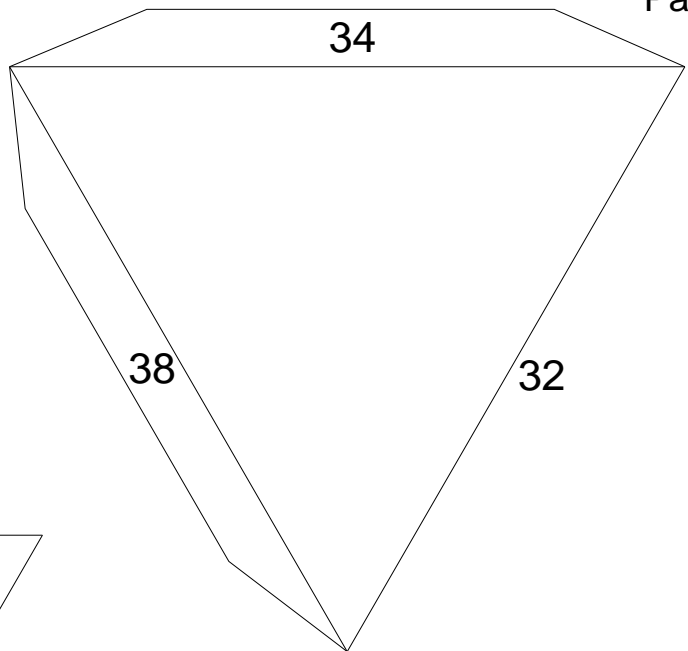

Part 37

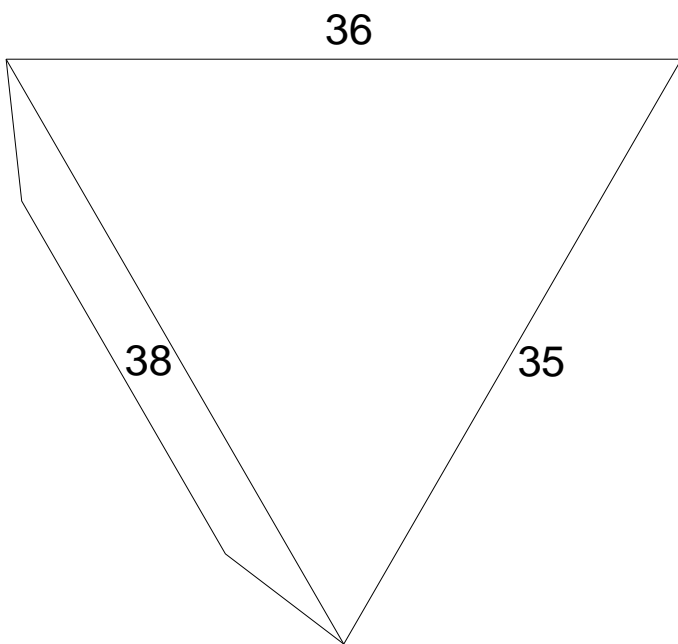

Snub Cube (left-handed)

Part 4

Color 3

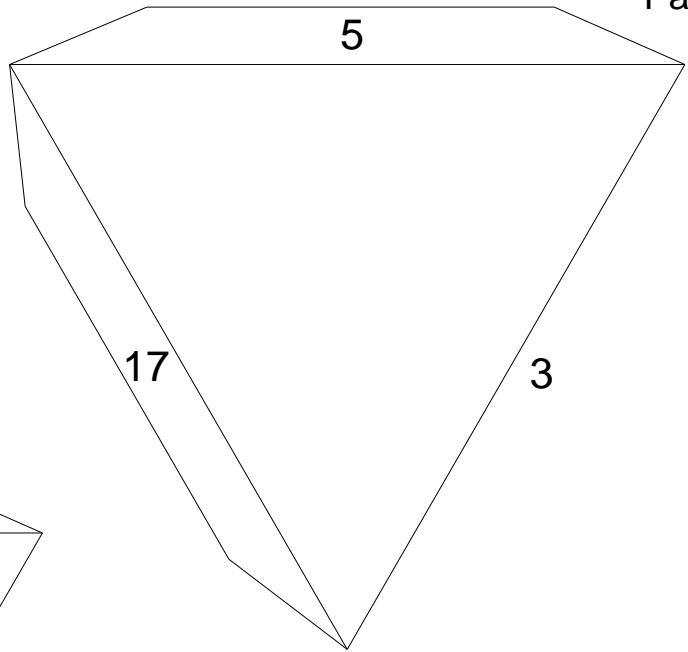

Part 10

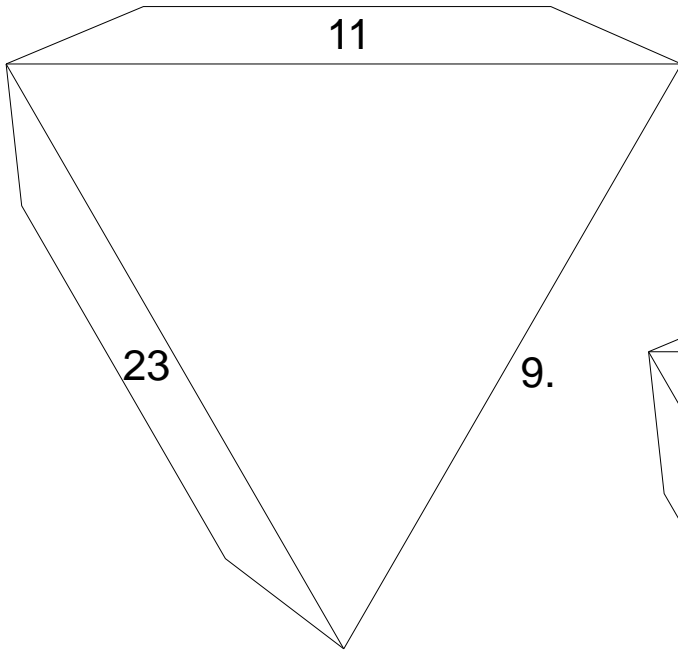

Part 16

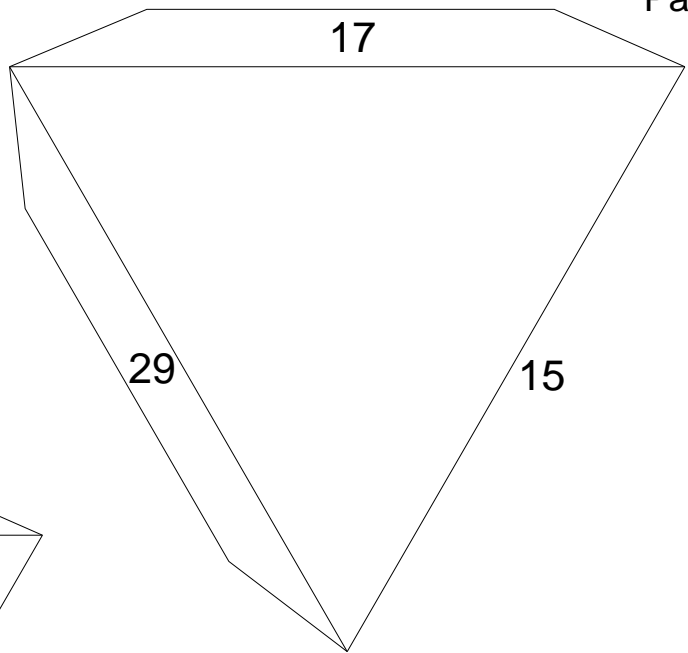

Part 18

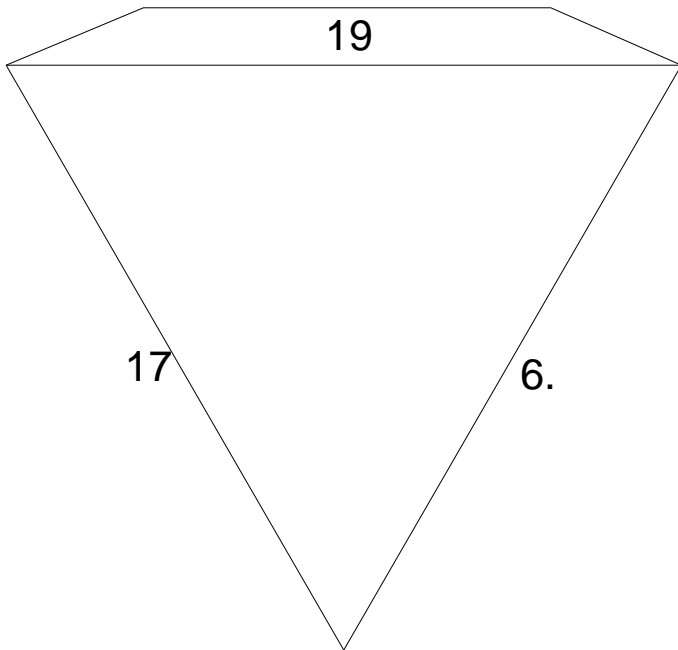

Snub Cube (left-handed)

Part 22

Color 3

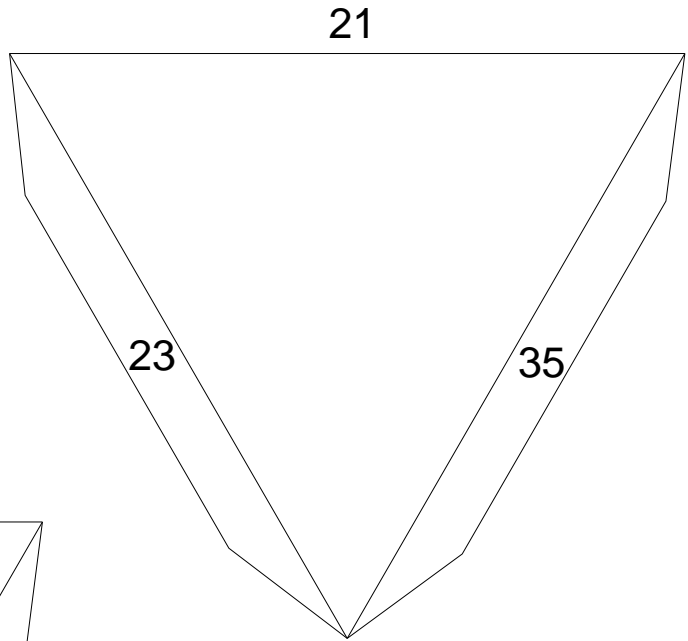

Part 24

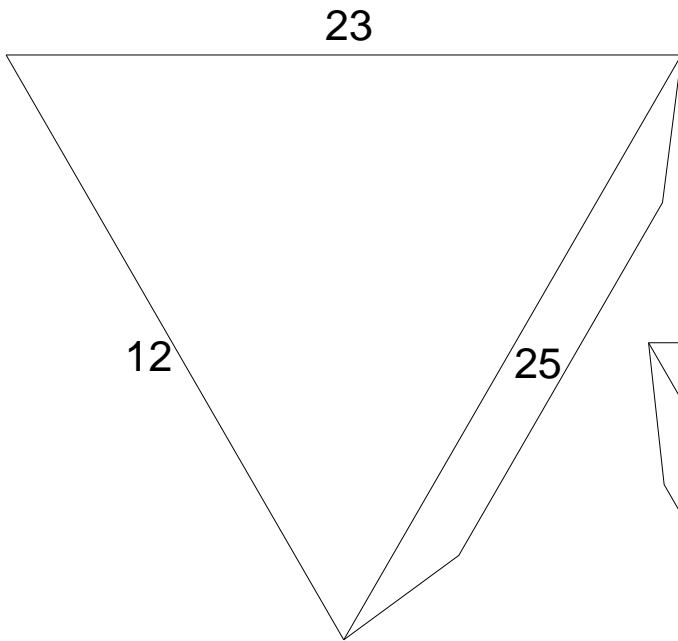

Part 31

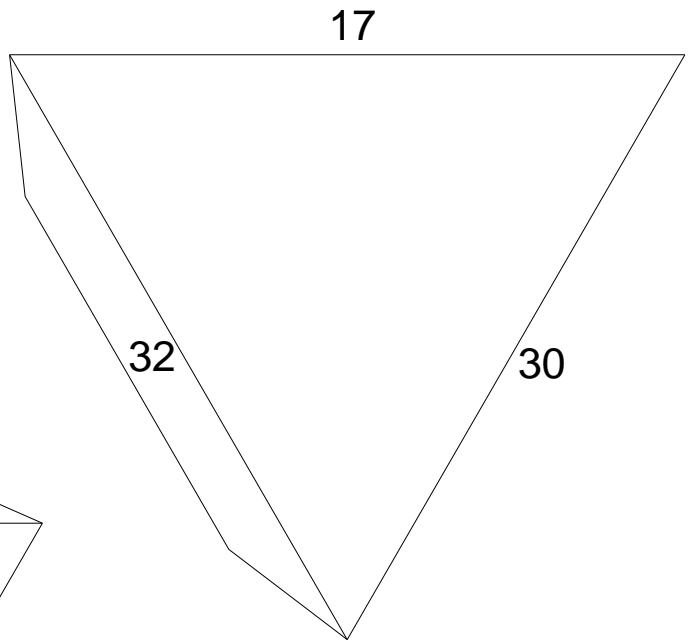

Part 36

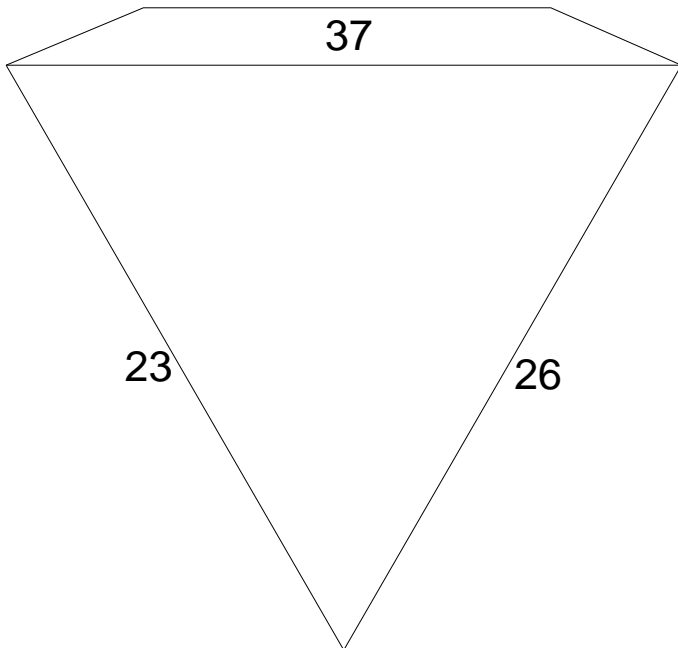

Snub Cube (left-handed)

Color 4

Part 7

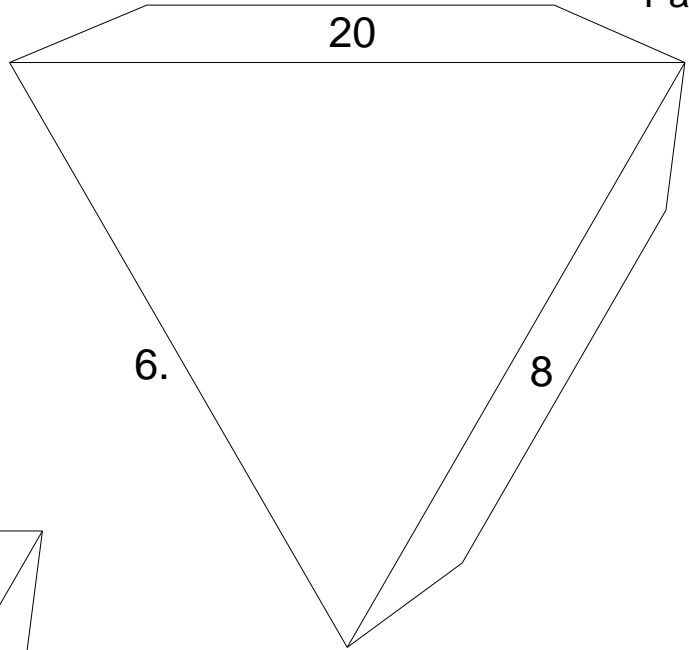

Part 13

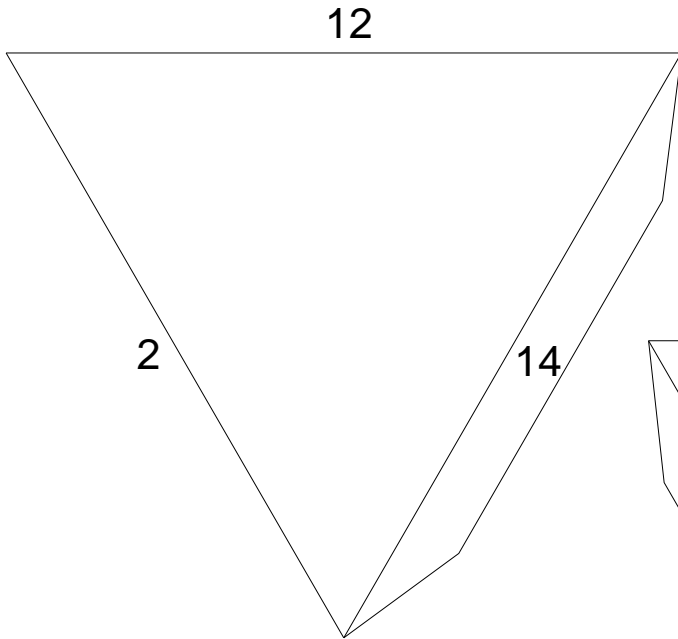

Part 15

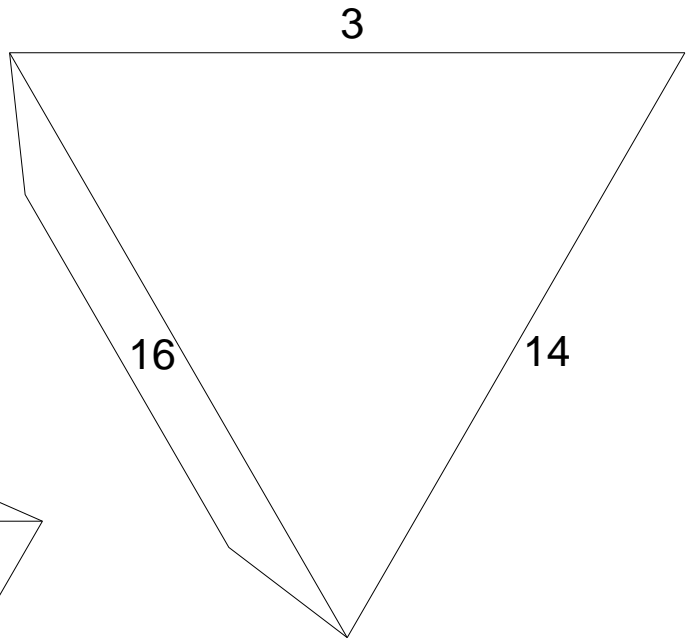

Part 19

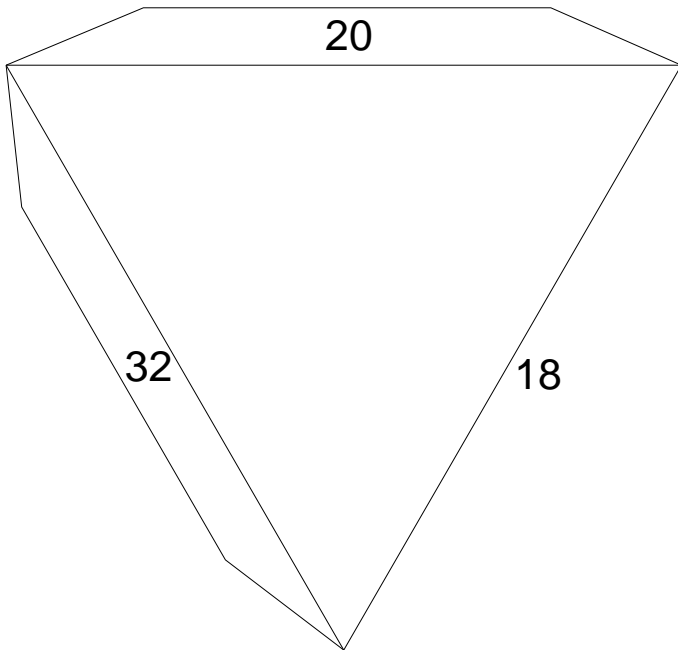

Snub Cube (left-handed)

Part 21

Color 4

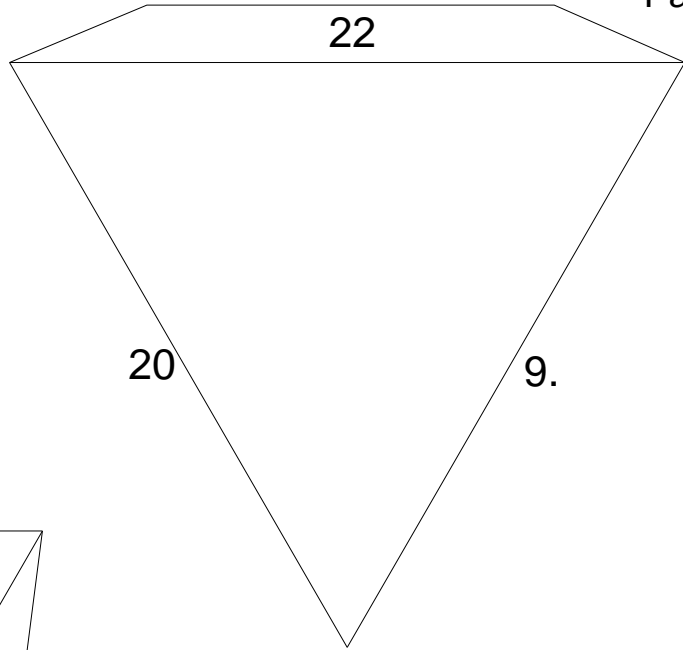

Part 25

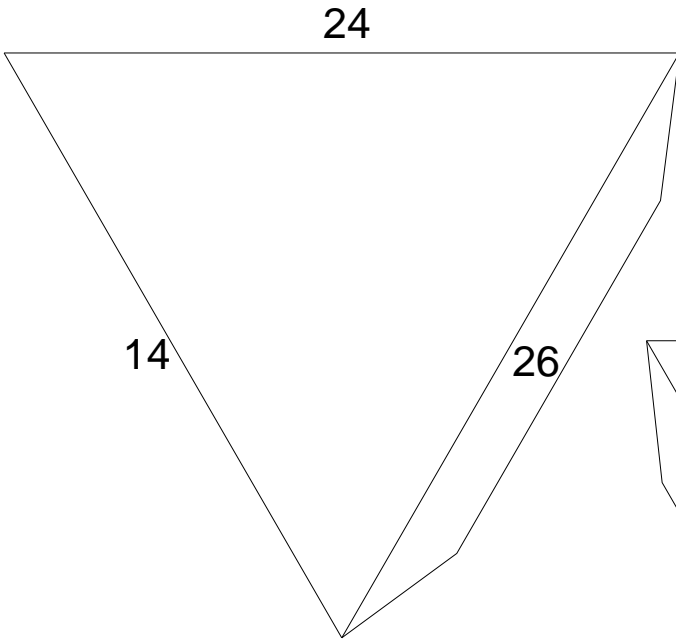

Part 28

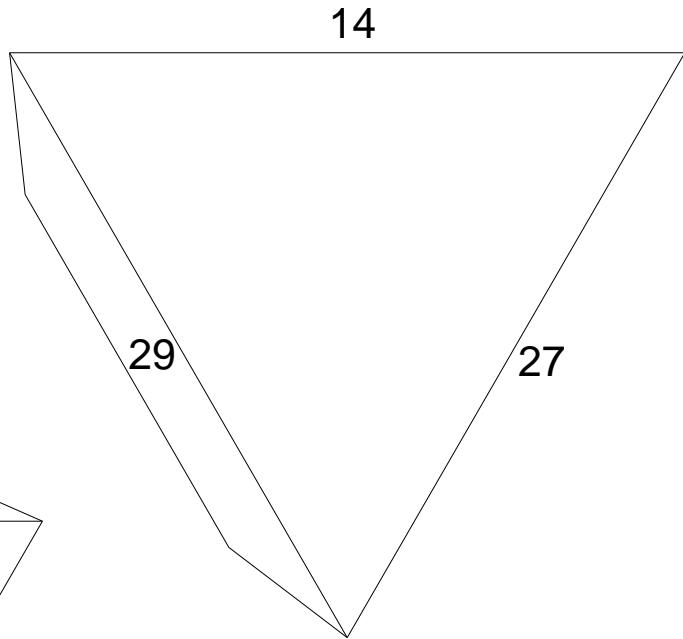

Part 34

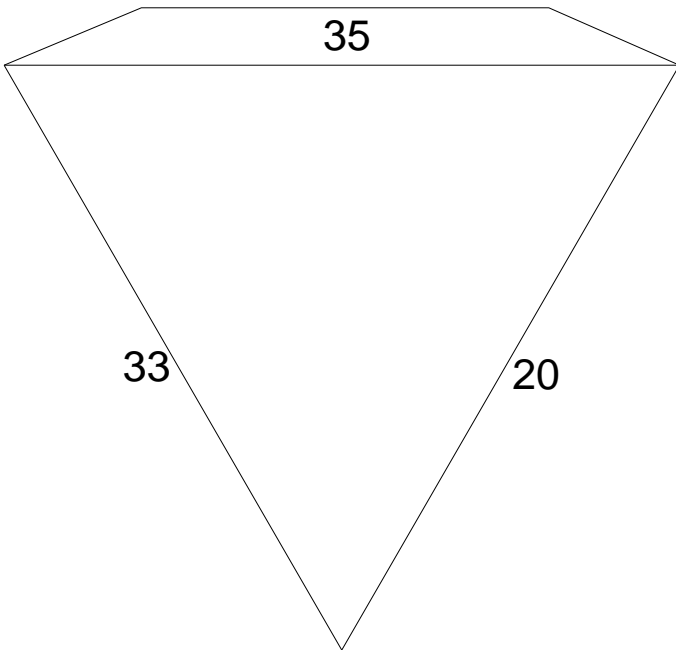

Snub Cube (left-handed)

Color 5

Part 3

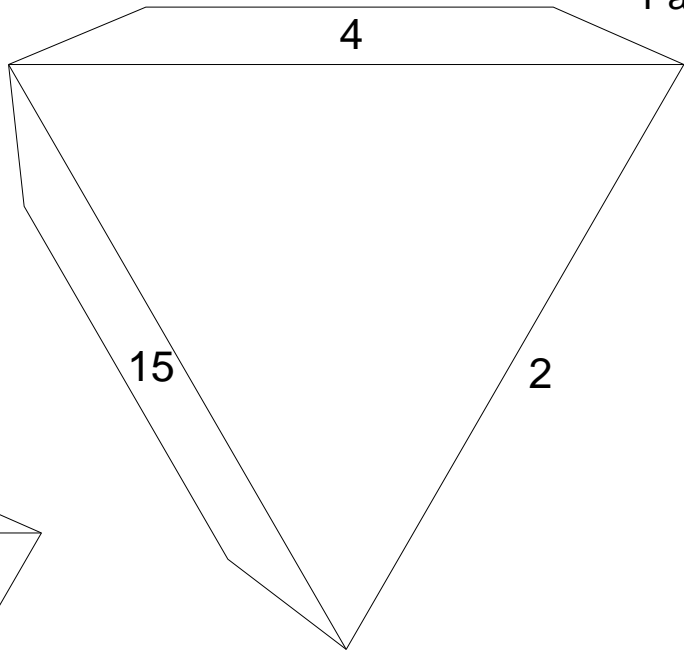

Part 6.

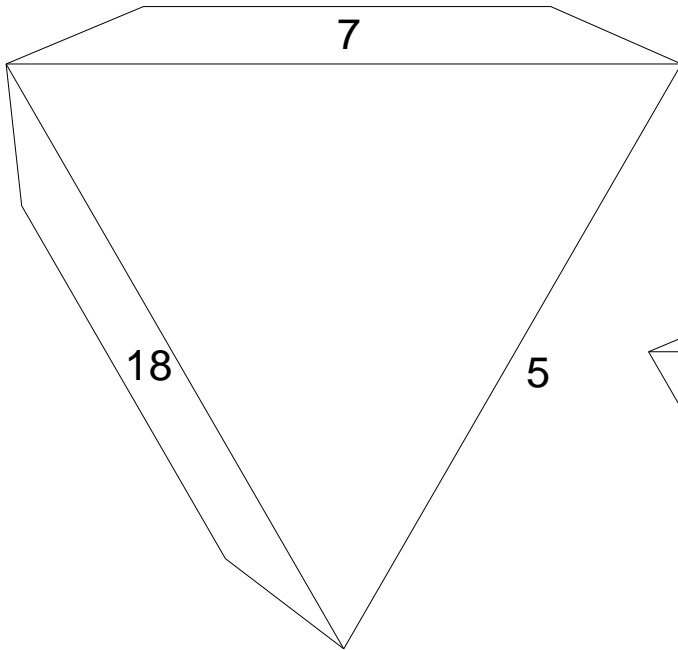

Part 9.

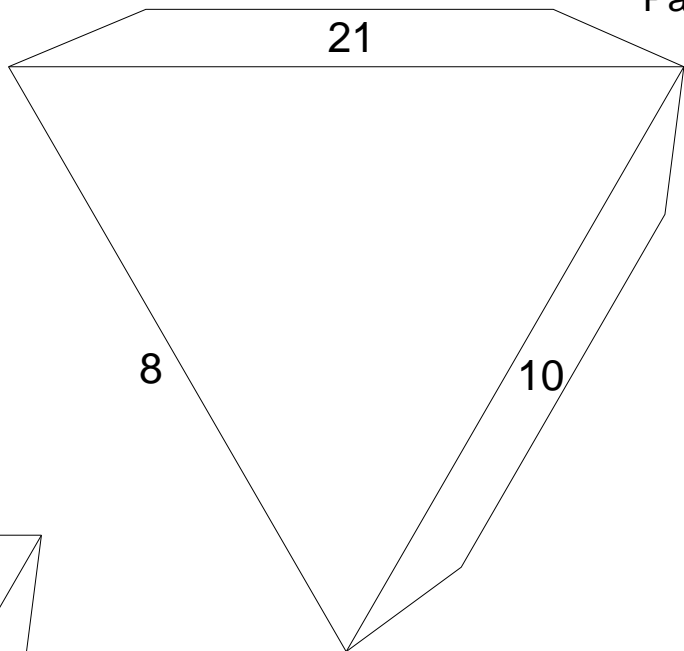

Part 12

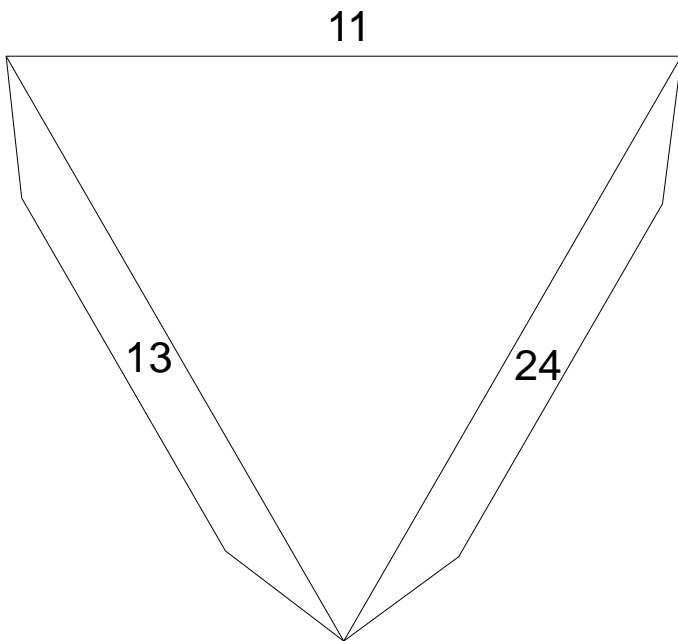

Snub Cube (left-handed)

Part 26

Color 5

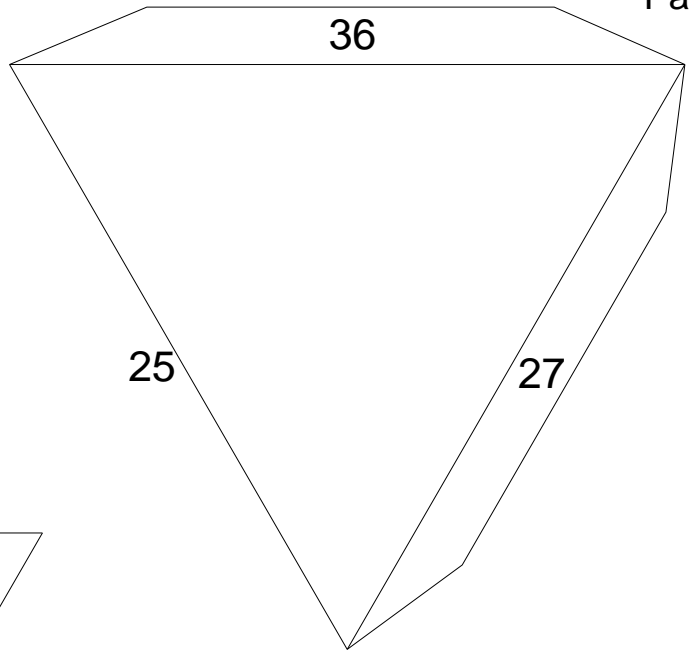

Part 29

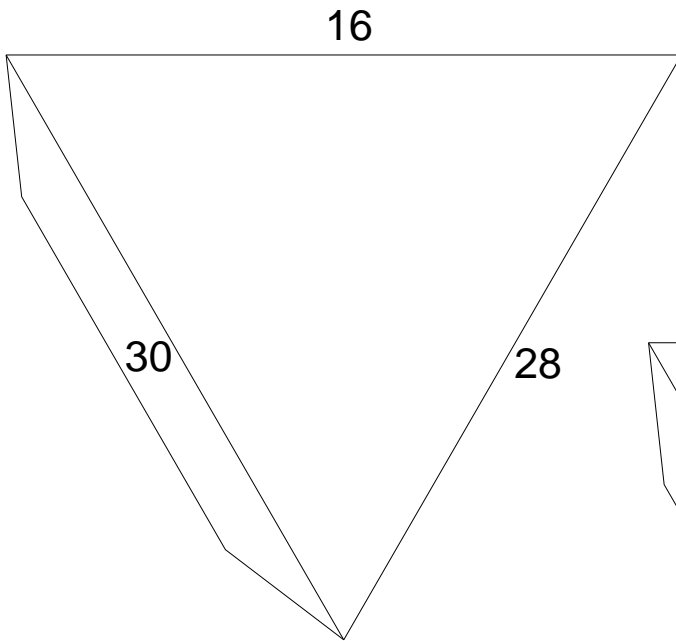

Part 32

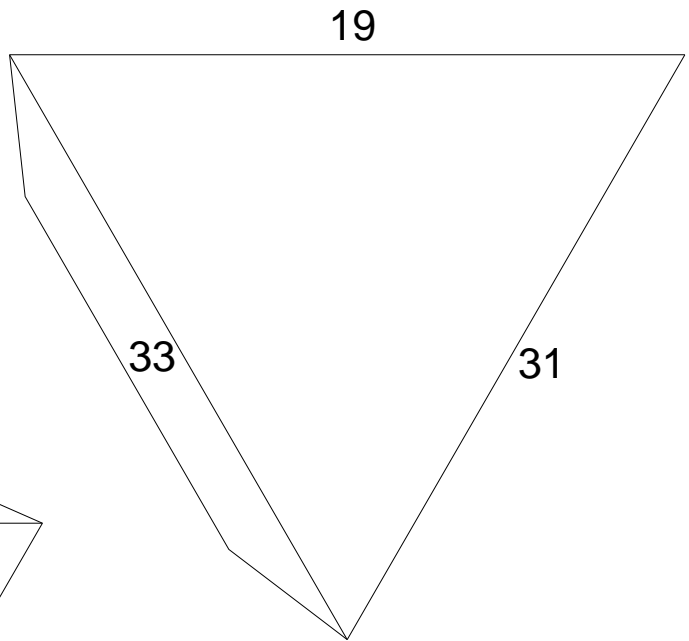

Part 35

