

# Rhombicosdodecahedron

Print the model on three  
different colored papers  
Color 1: four pages  
Color 2: five pages  
Color 3: two page.  
Color 1

Part 1

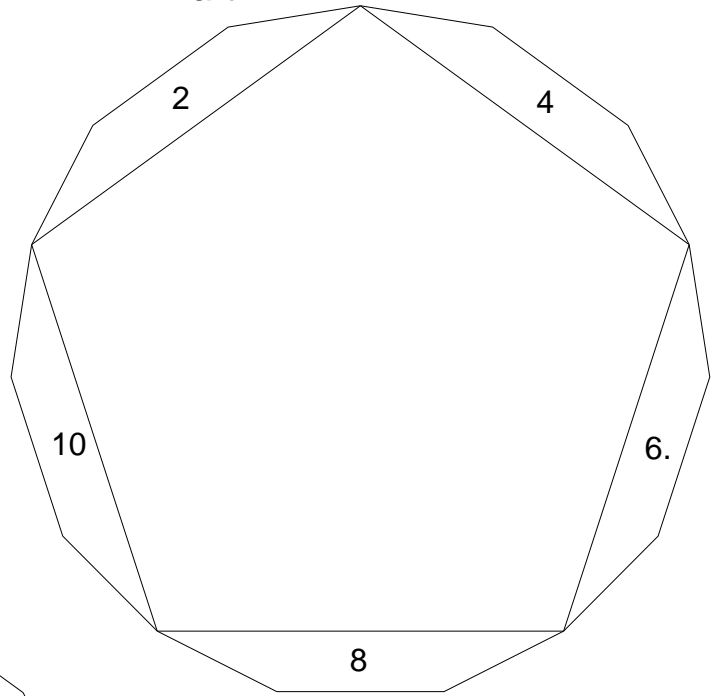

Part 13

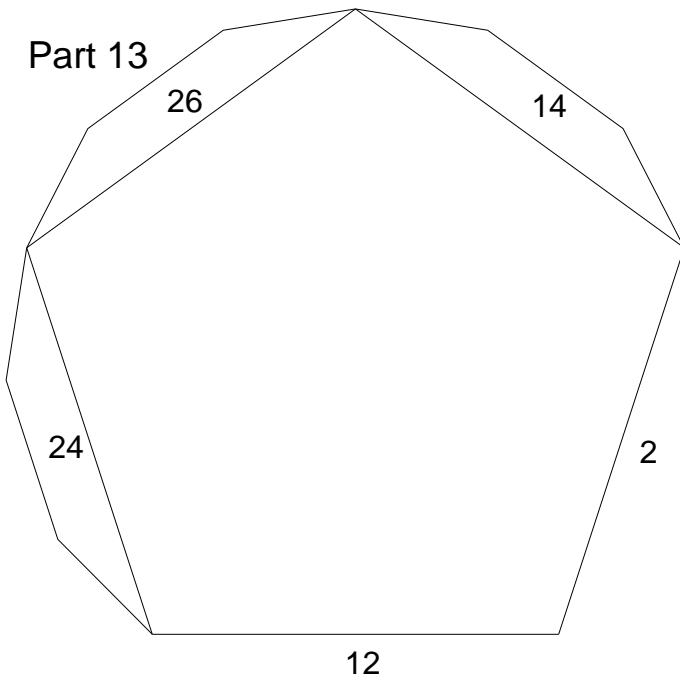

Part 15

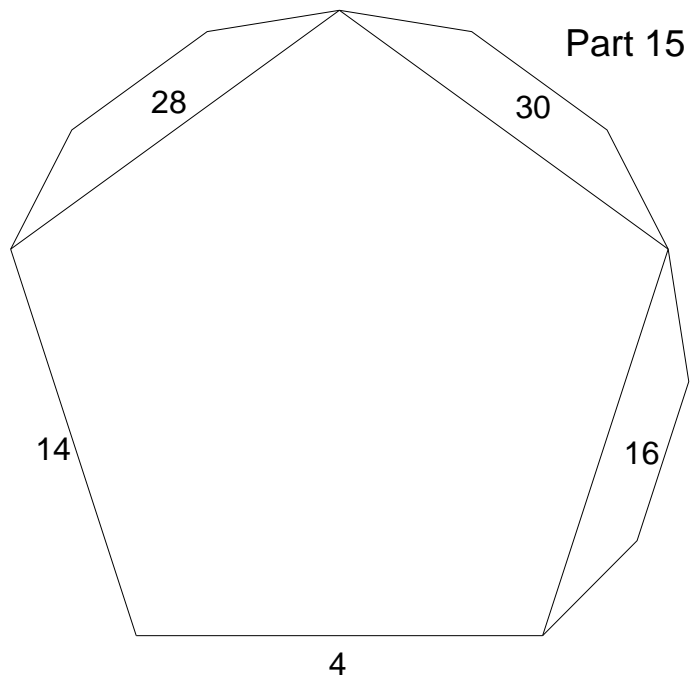

1. Start with part 1 and glue part 2 on the tab of part 1 with the number 2.
  2. Glue part 3 on the parts 1 and 2 on the tab(s) with the number 3.
  3. Glue part 4 on the parts 1, 2 and 3 on the tab(s) with the number 4.
- Etc.

# Rhombicosdodecahedron

Color 1

Part 17

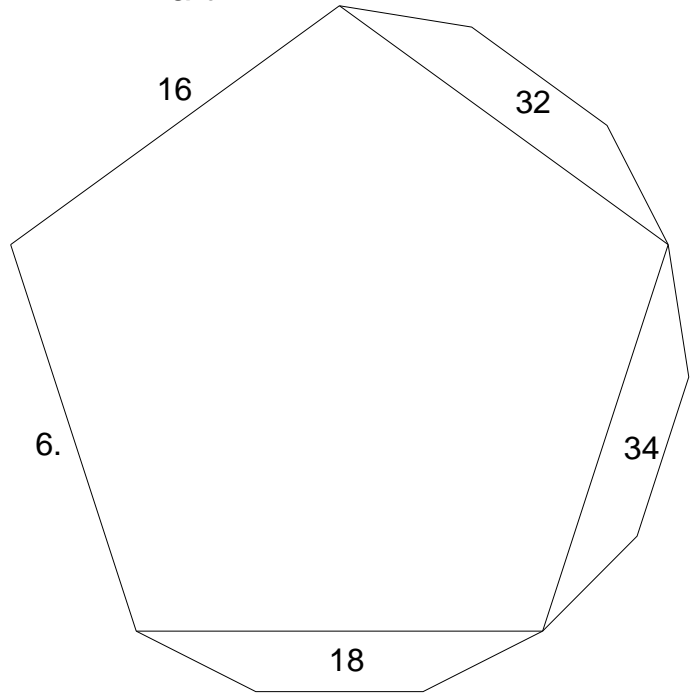

Part 19

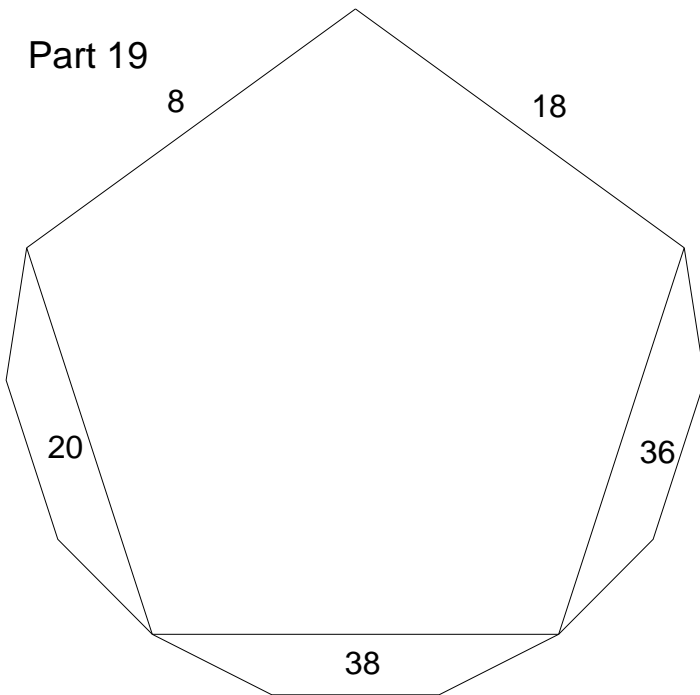

Part 21

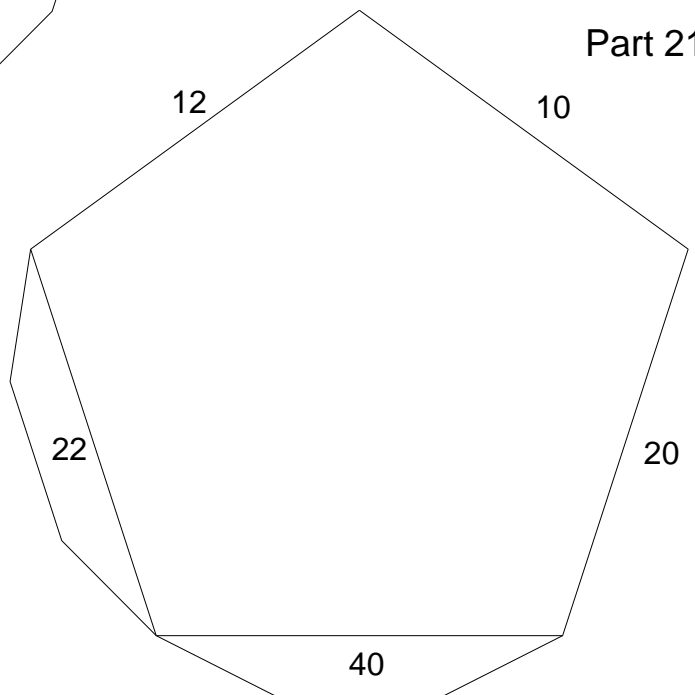

# Rhombicosdodecahedron

Color 1

Part 43

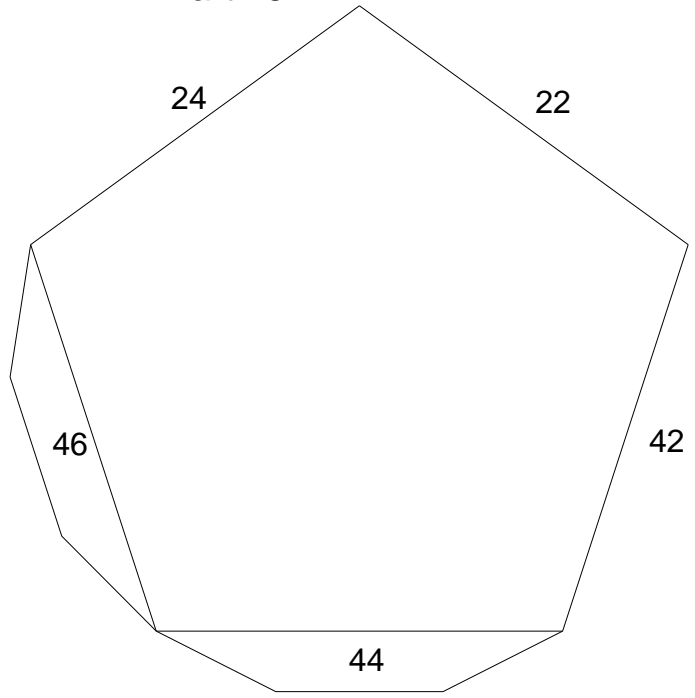

Part 47

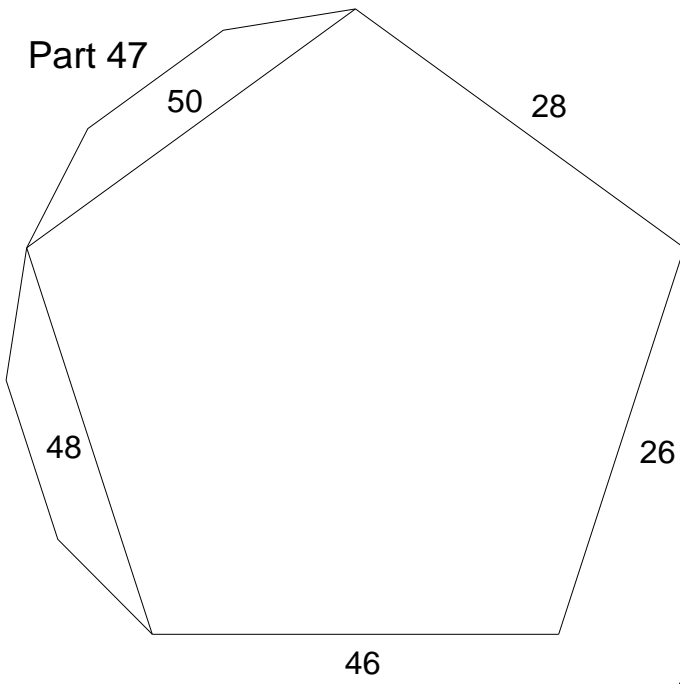

Part 51

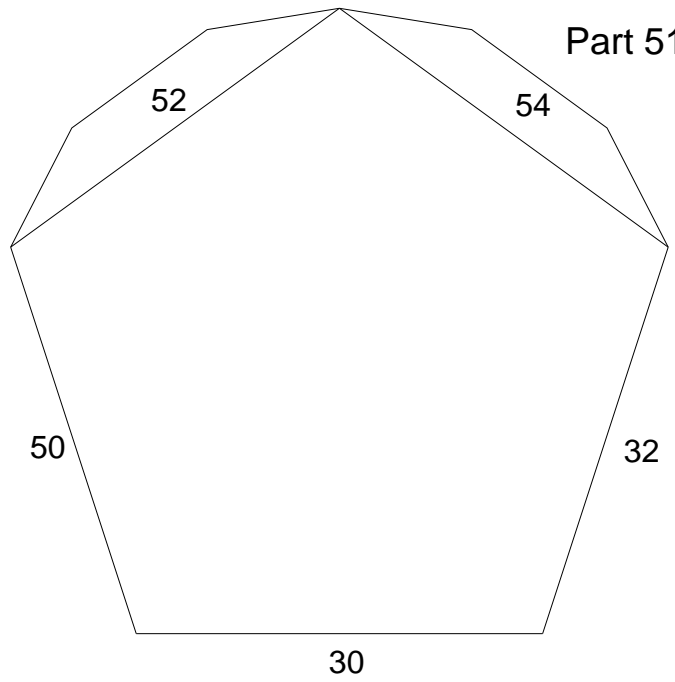

# Rhombicosdodecahedron

Color 1

Part 55

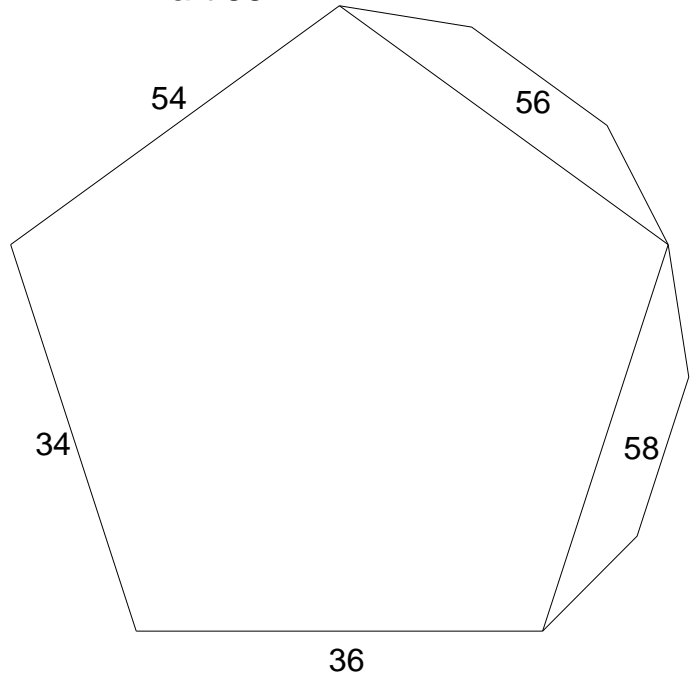

Part 59

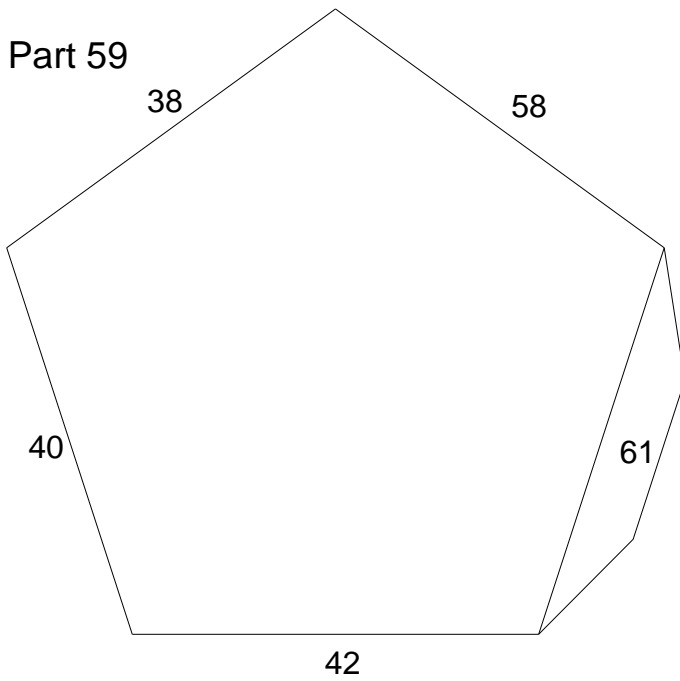

Part 62

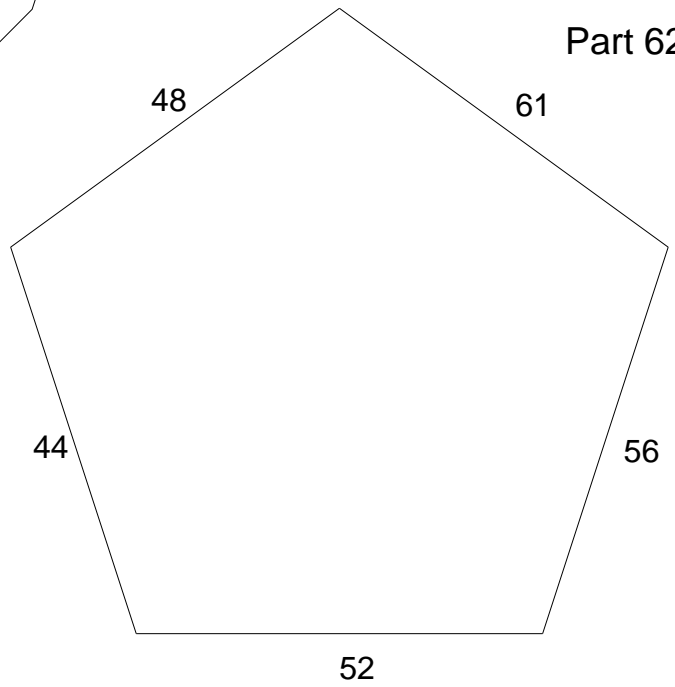

# Rhombicosdodecahedron

Color 2

Part 2

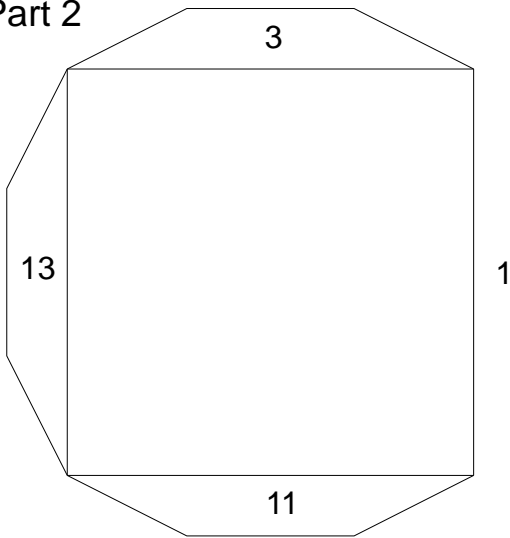

Part 4

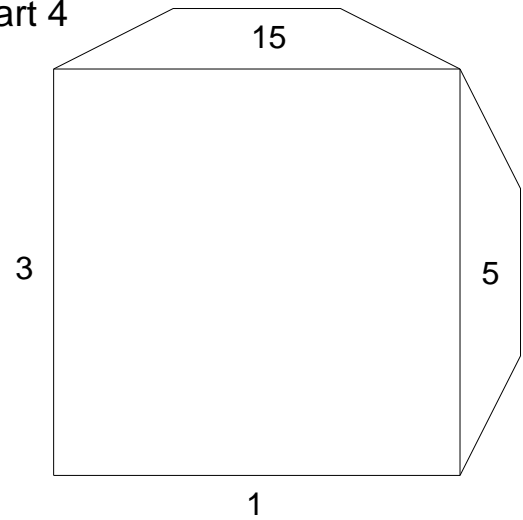

Part 6.

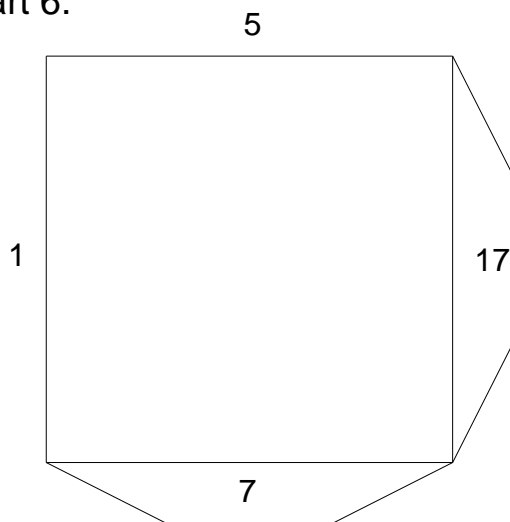

Part 8

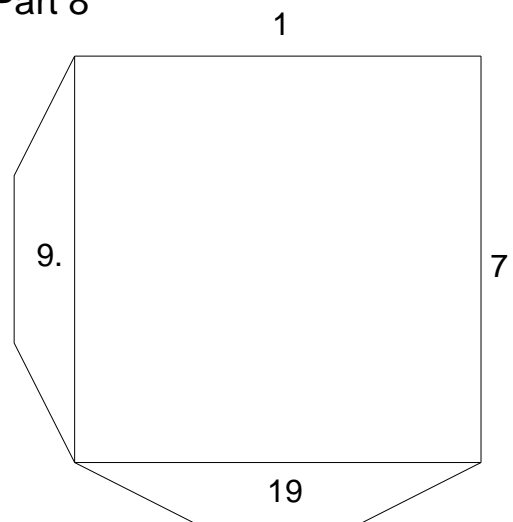

Part 10

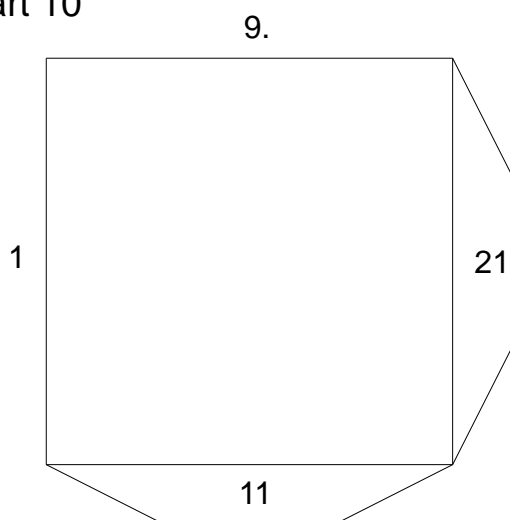

Part 12

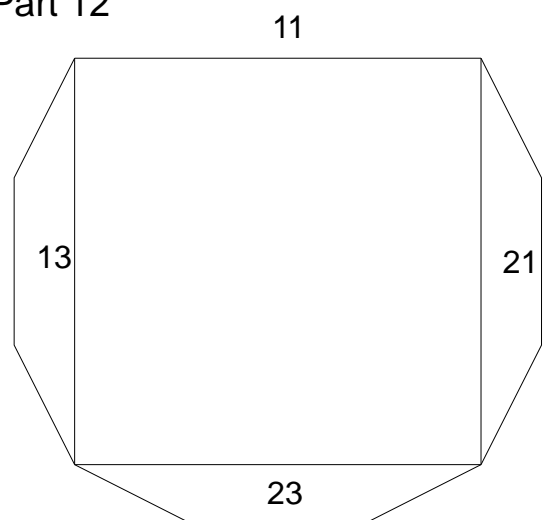

# Rhombicosdodecahedron

Color 2

Part 14

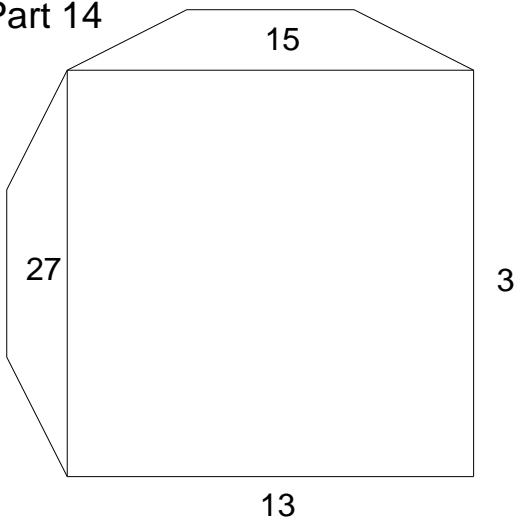

Part 16

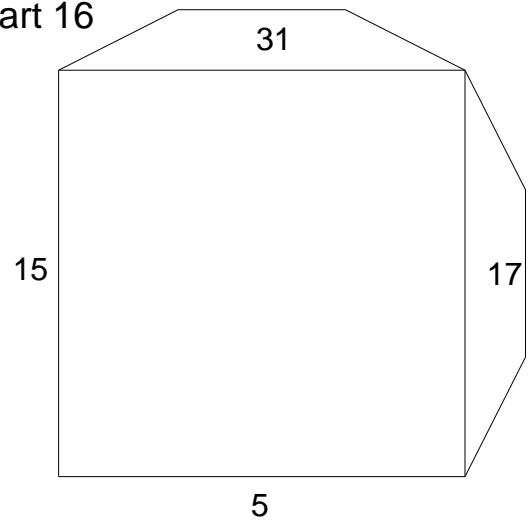

Part 18

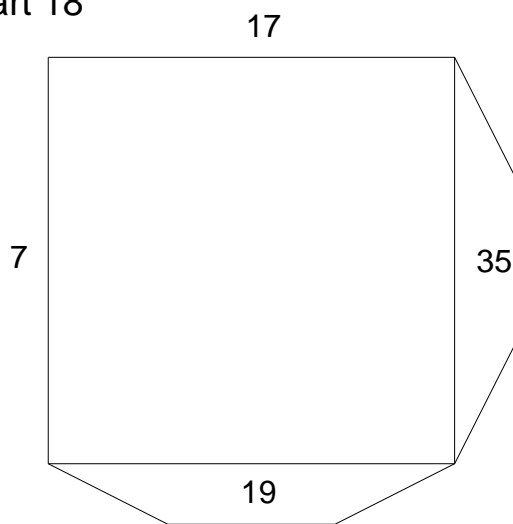

Part 20

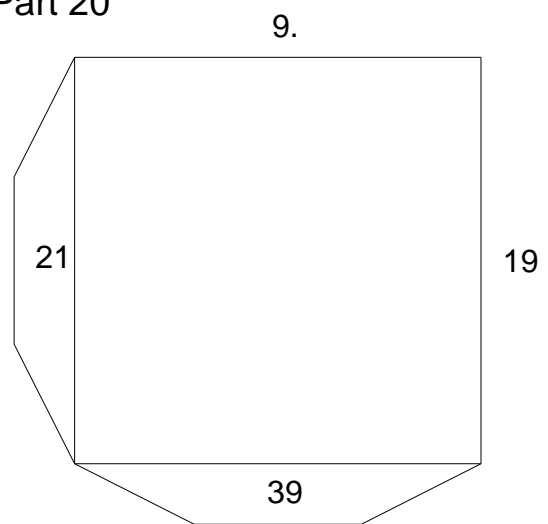

Part 22

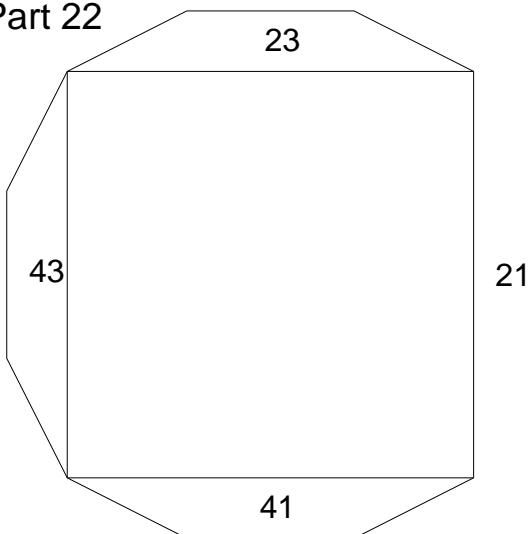

Part 24

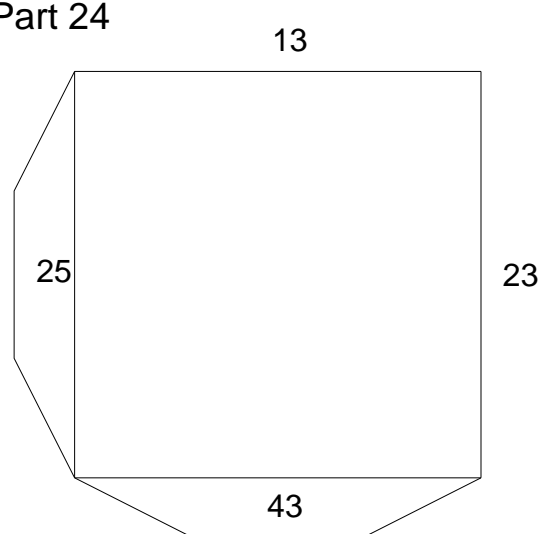

# Rhombicosdodecahedron

Color 2

Part 26

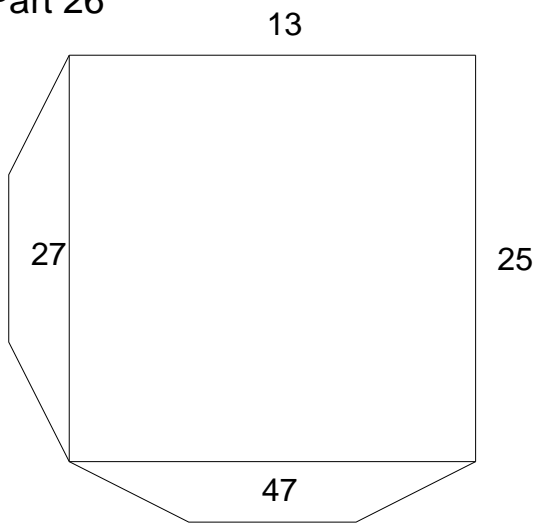

Part 28

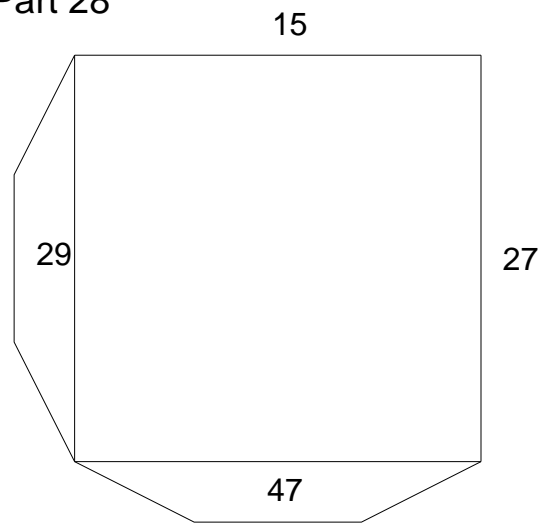

Part 30

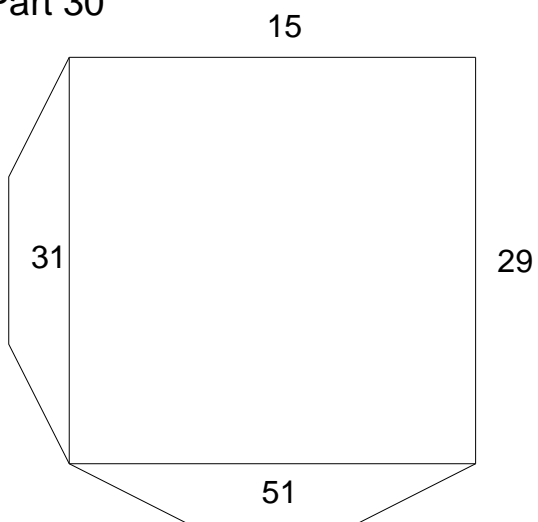

Part 32

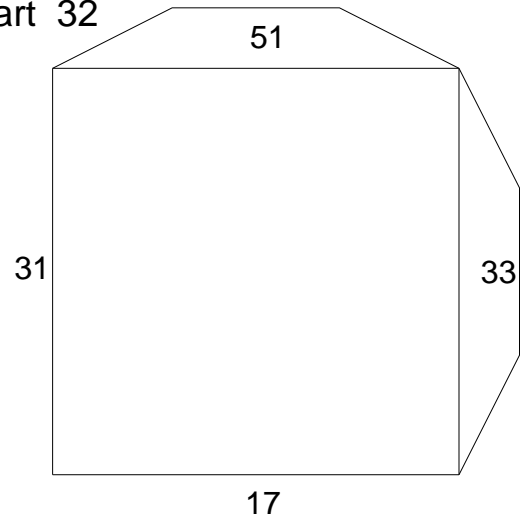

Part 34

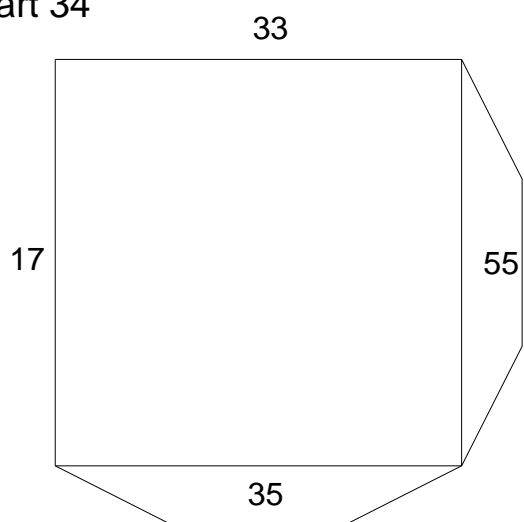

Part 36

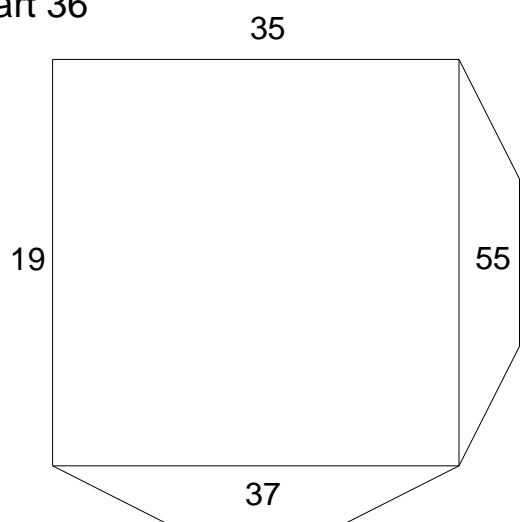

# Rhombicosdodecahedron

Color 2

Part 38

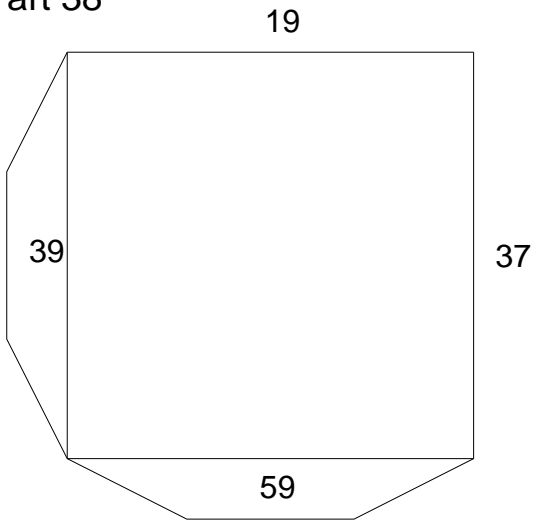

Part 40

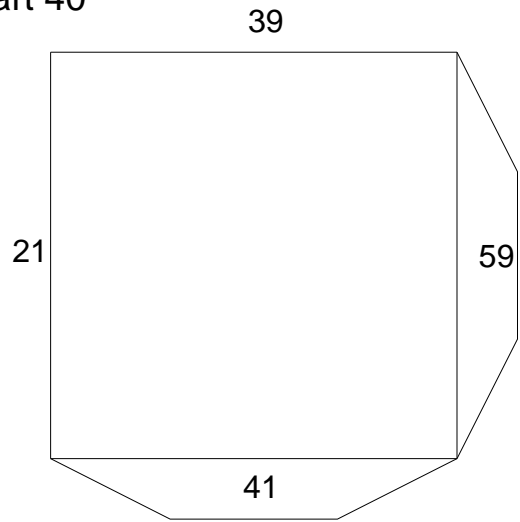

Part 42

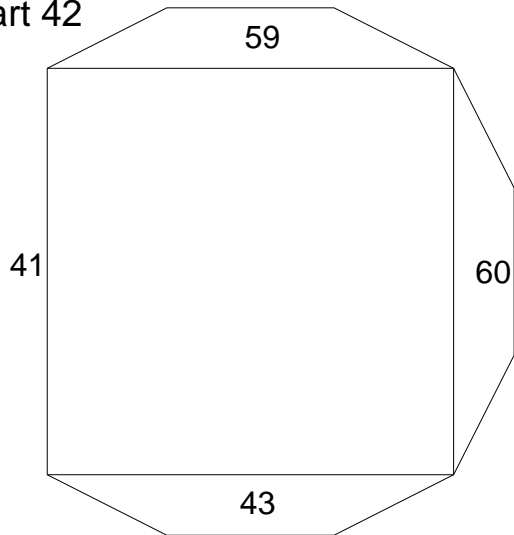

Part 44

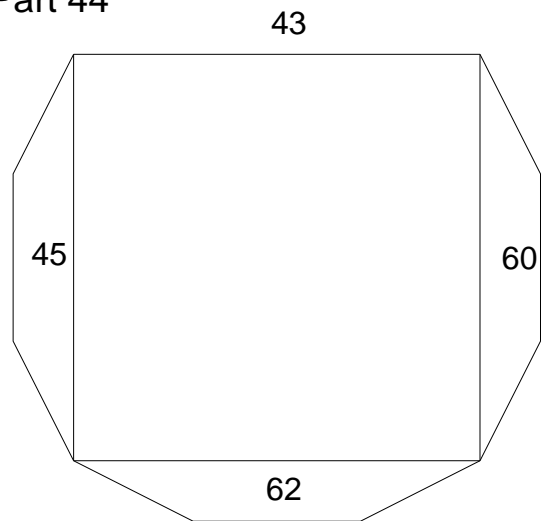

Part 46

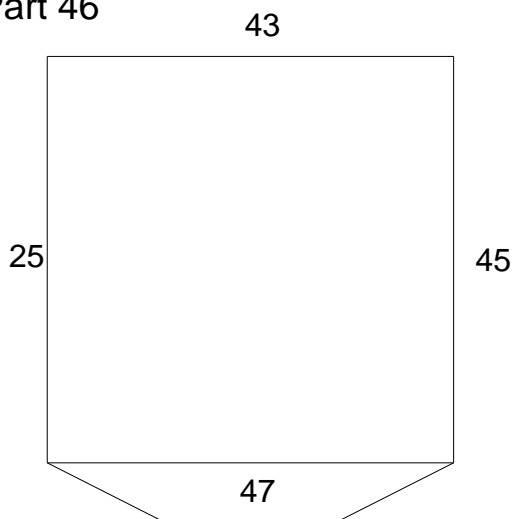

Part 48

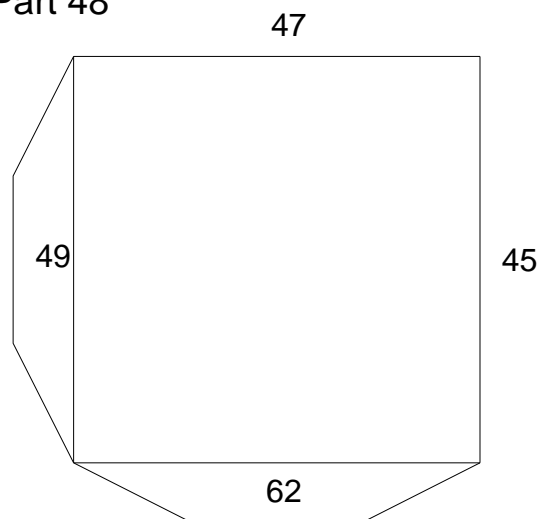



# Rhombicosdodecahedron

Color 2

Part 50

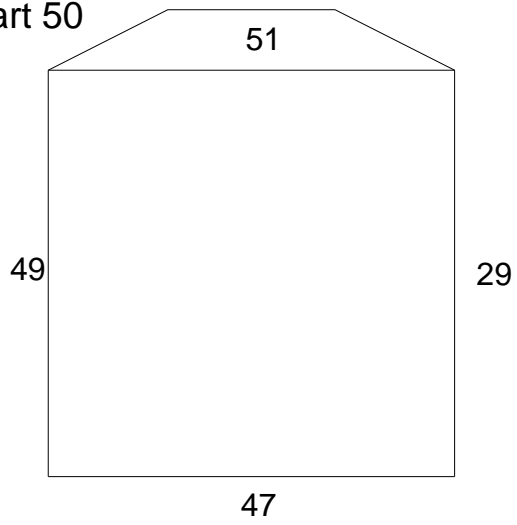

Part 52

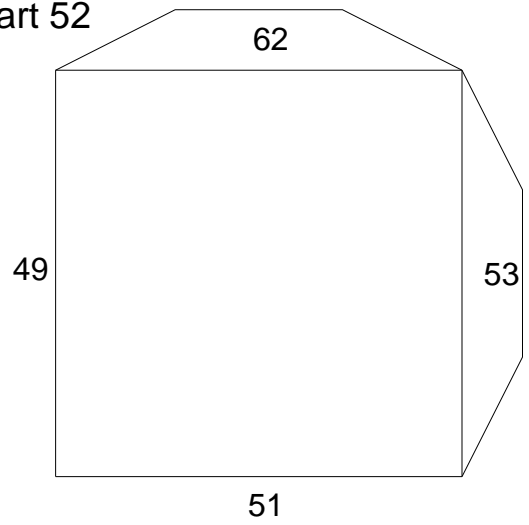

Part 54

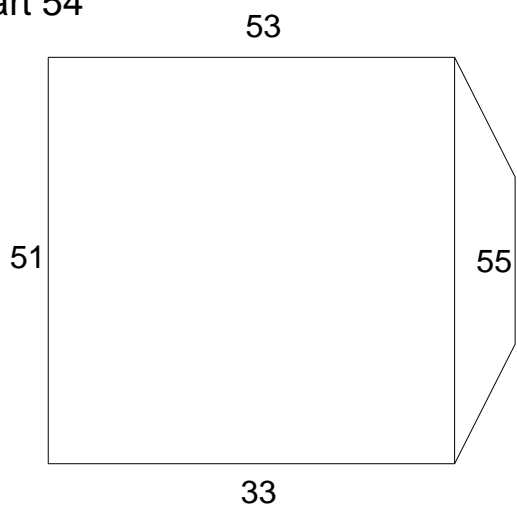

Part 56

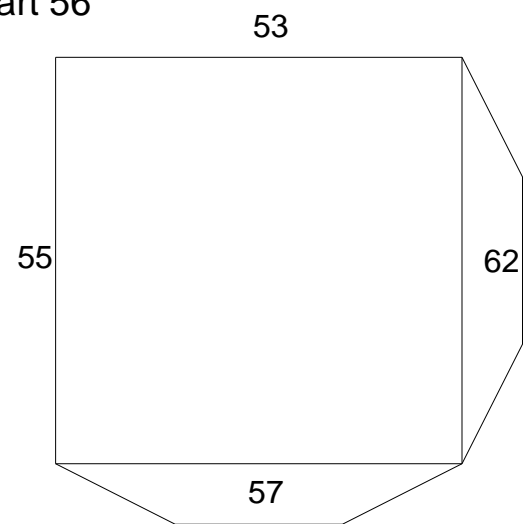

Part 58

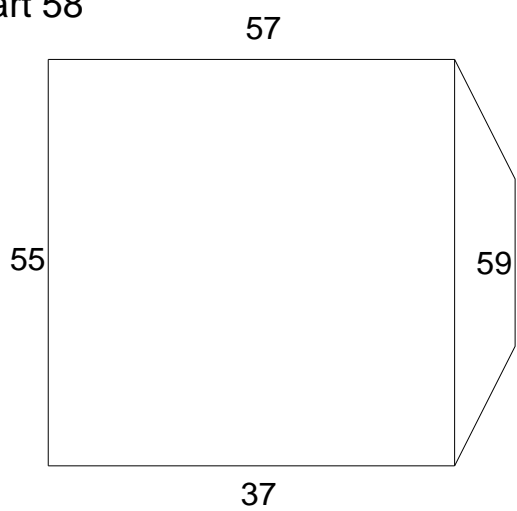

Part 61

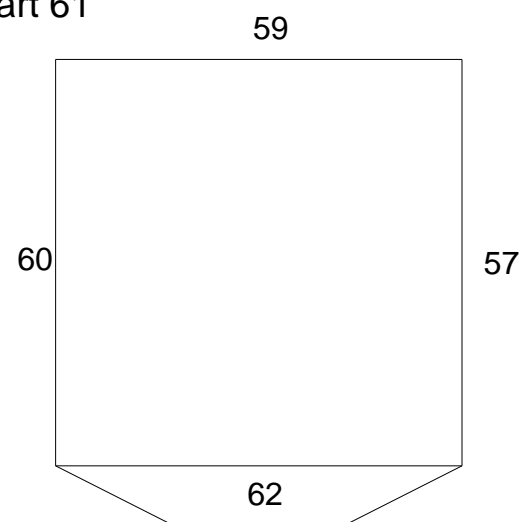

# Rhombicosdodecahedron

Color 3

Part 3

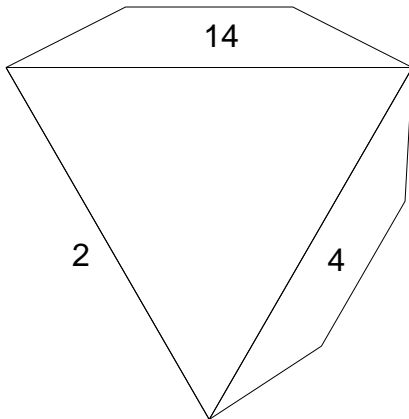

Part 5

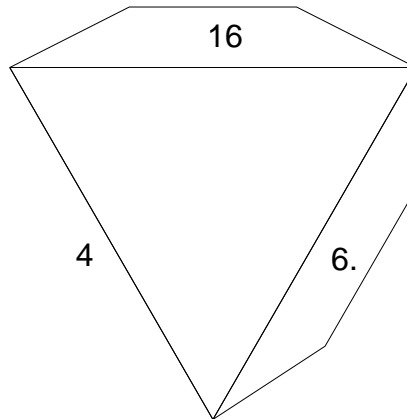

Part 7

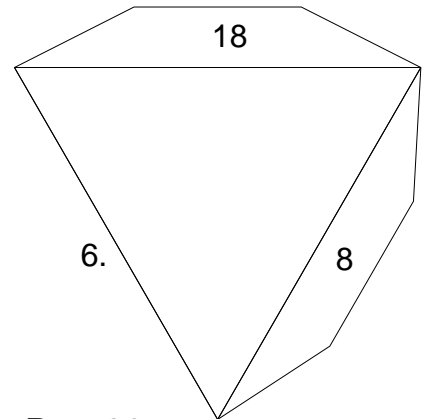

Part 9

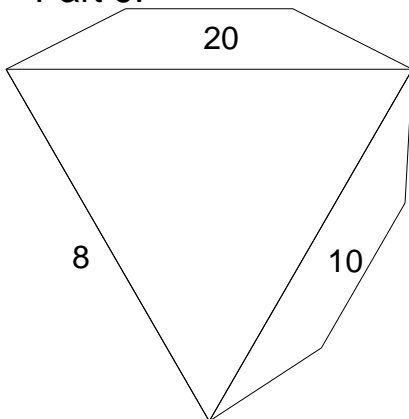

Part 11

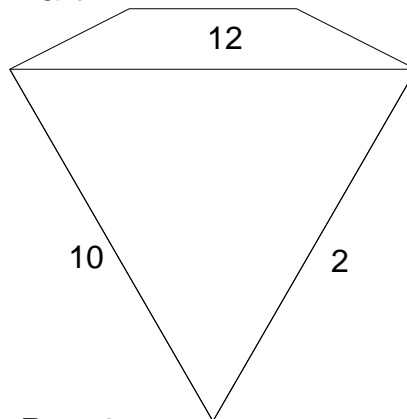

Part 23

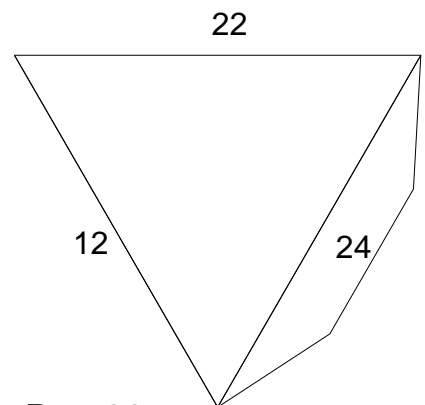

Part 25

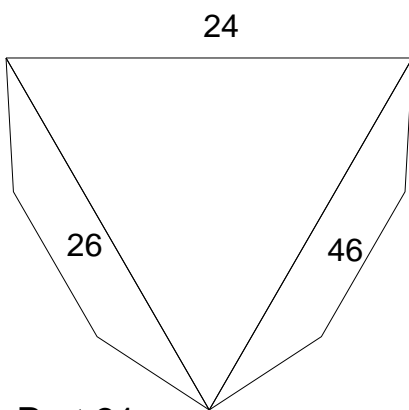

Part 27

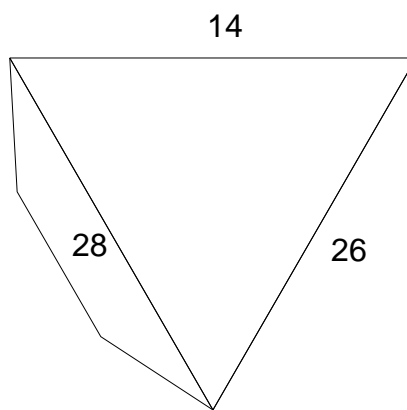

Part 29

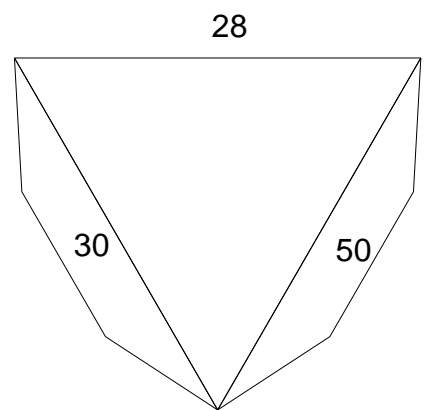

Part 31

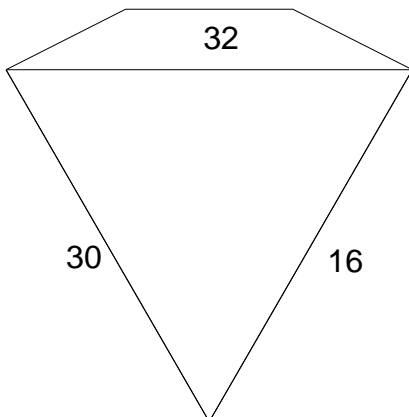

Part 33

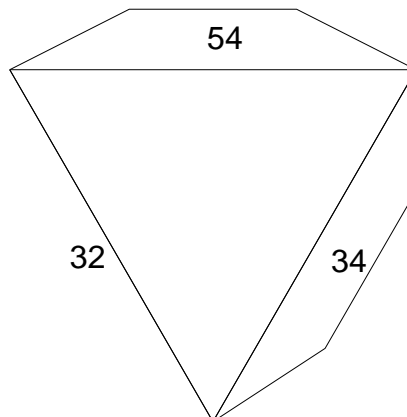

Part 35

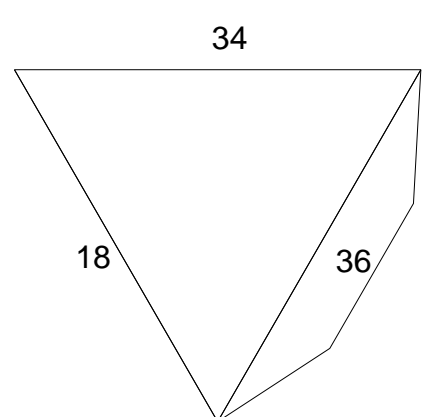

# Rhombicosdodecahedron

Color 3

Part 37

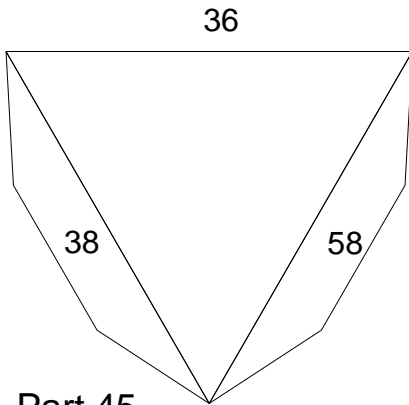

Part 39

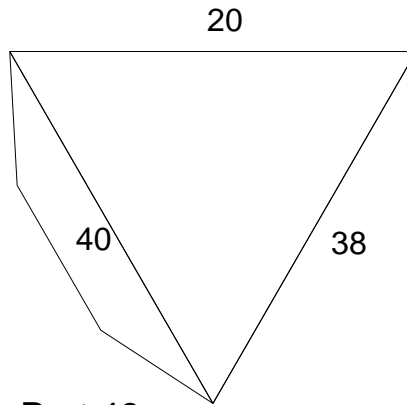

Part 41

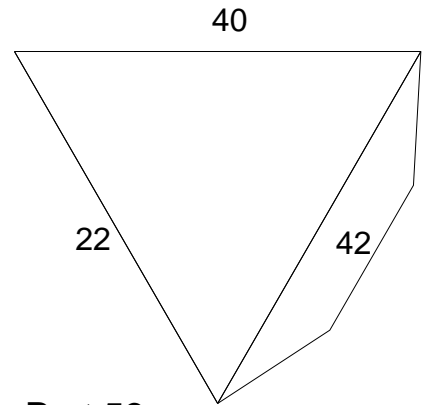

Part 45

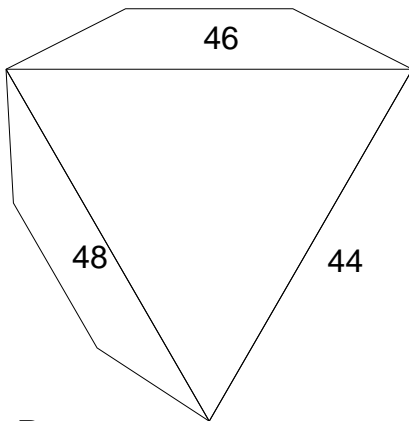

Part 49

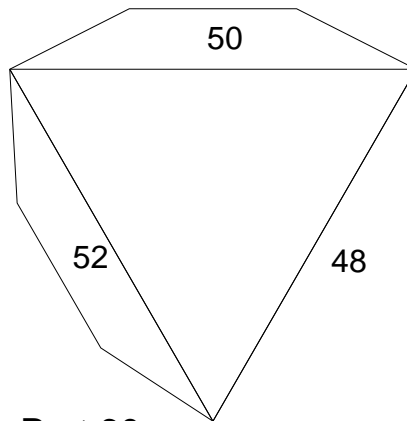

Part 53

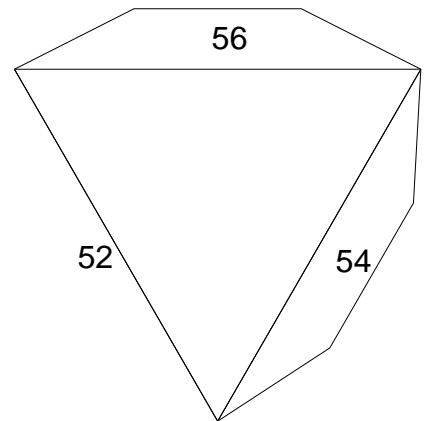

Part 57

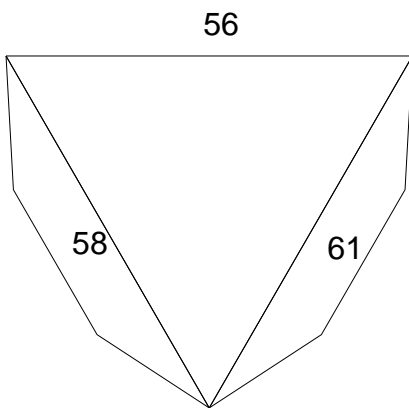

Part 60

