

Great Stellated Dodecahedron

Color 1

Part 1

Use paper in four colors: each color 8 sheets of paper
Fold the dotted lines forwards
Fold the other lines backwards

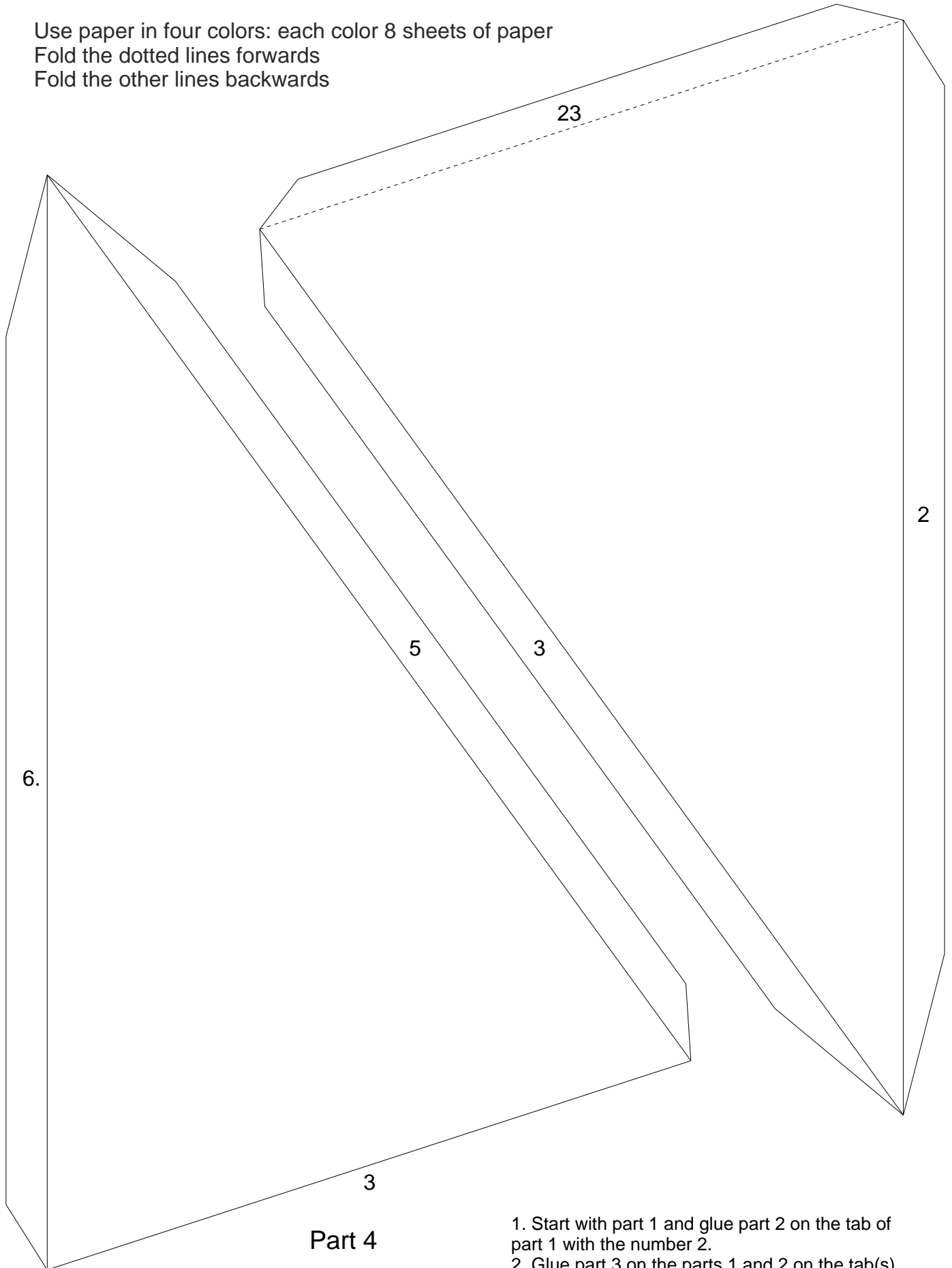

1. Start with part 1 and glue part 2 on the tab of part 1 with the number 2.
 2. Glue part 3 on the parts 1 and 2 on the tab(s) with the number 3.
 3. Glue part 4 on the parts 1, 2 and 3 on the tab(s) with the number 4.
- Etc.

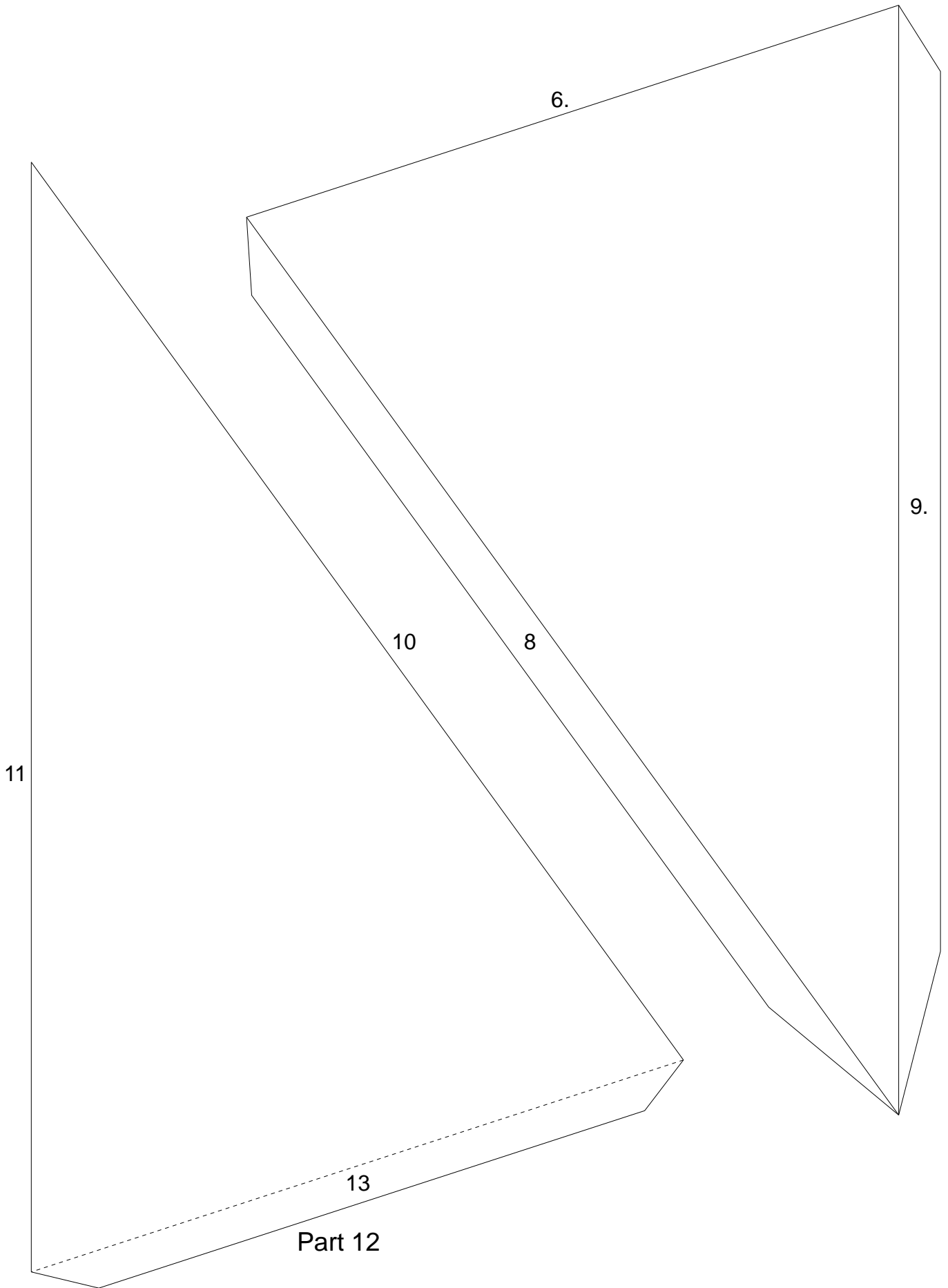

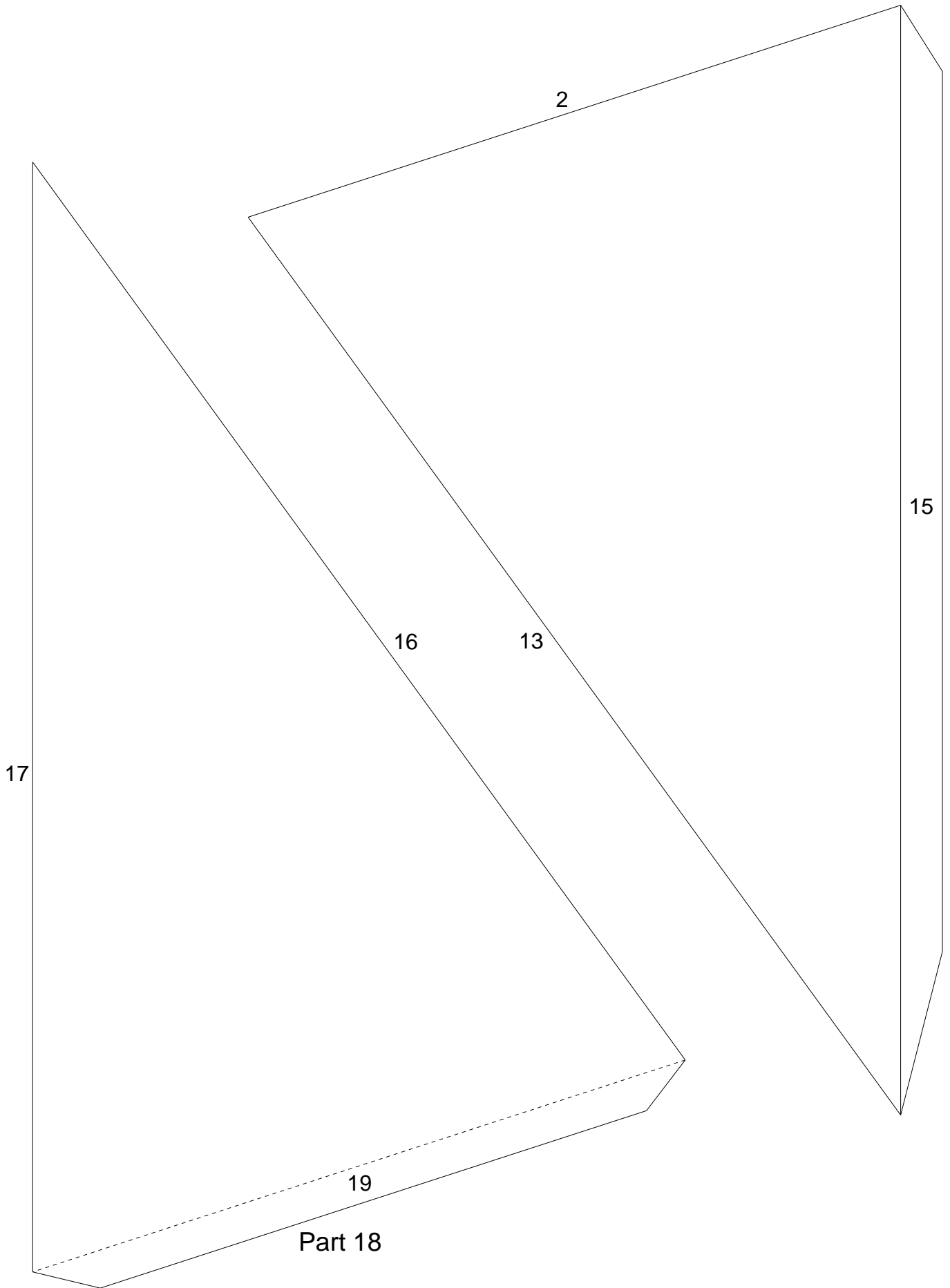

Great Stellated Dodecahedron

Color 1

Part 21

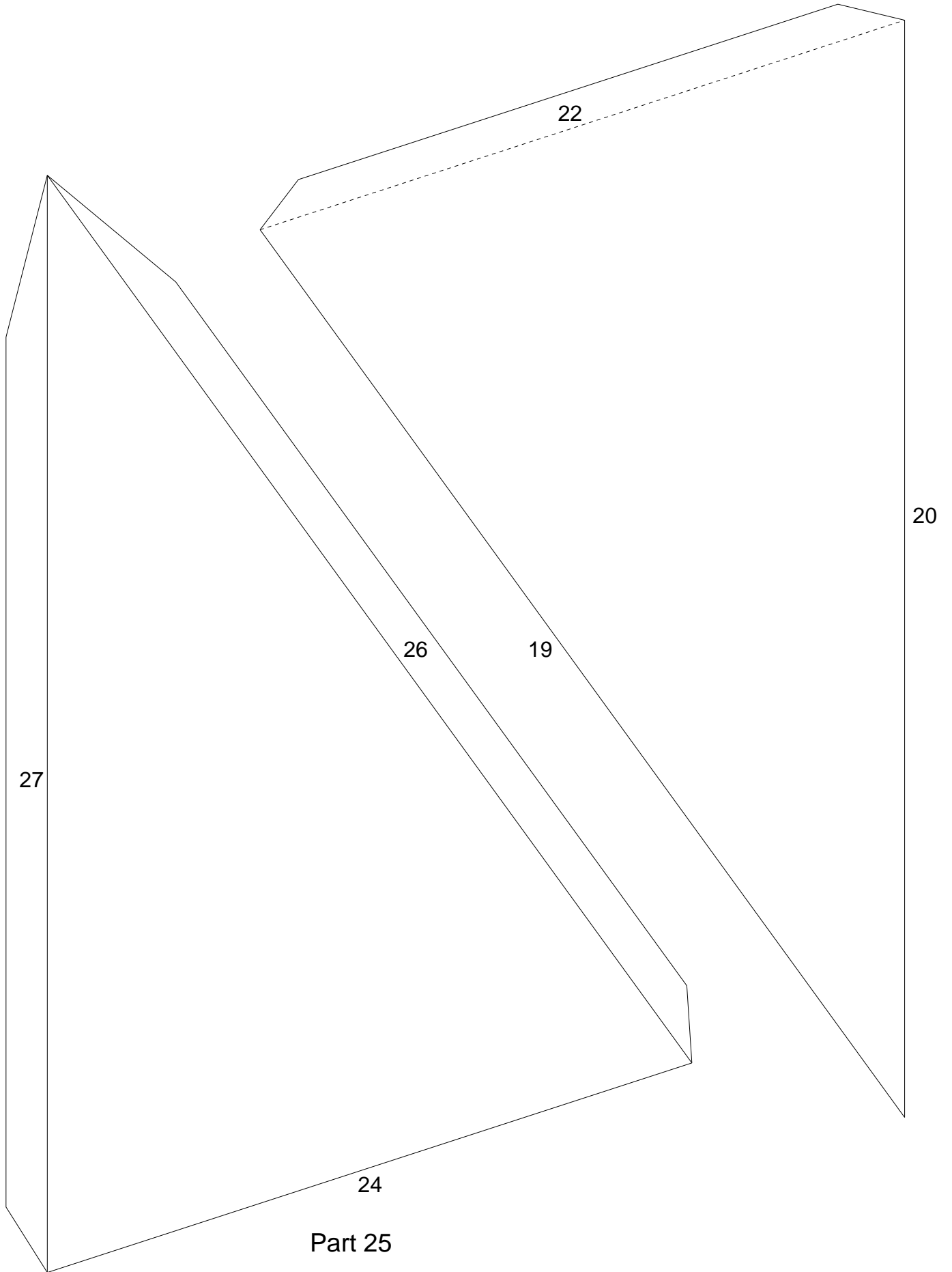

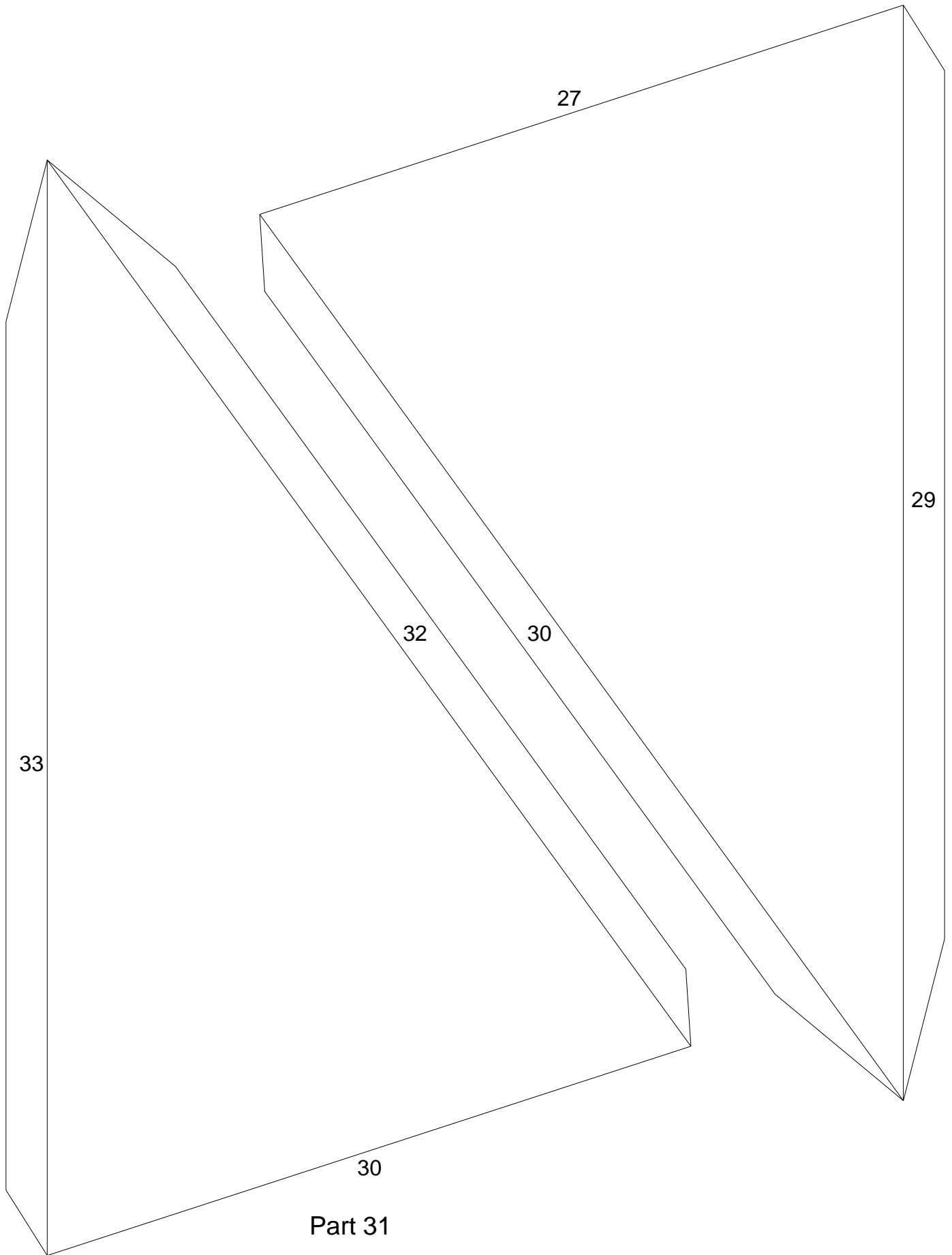

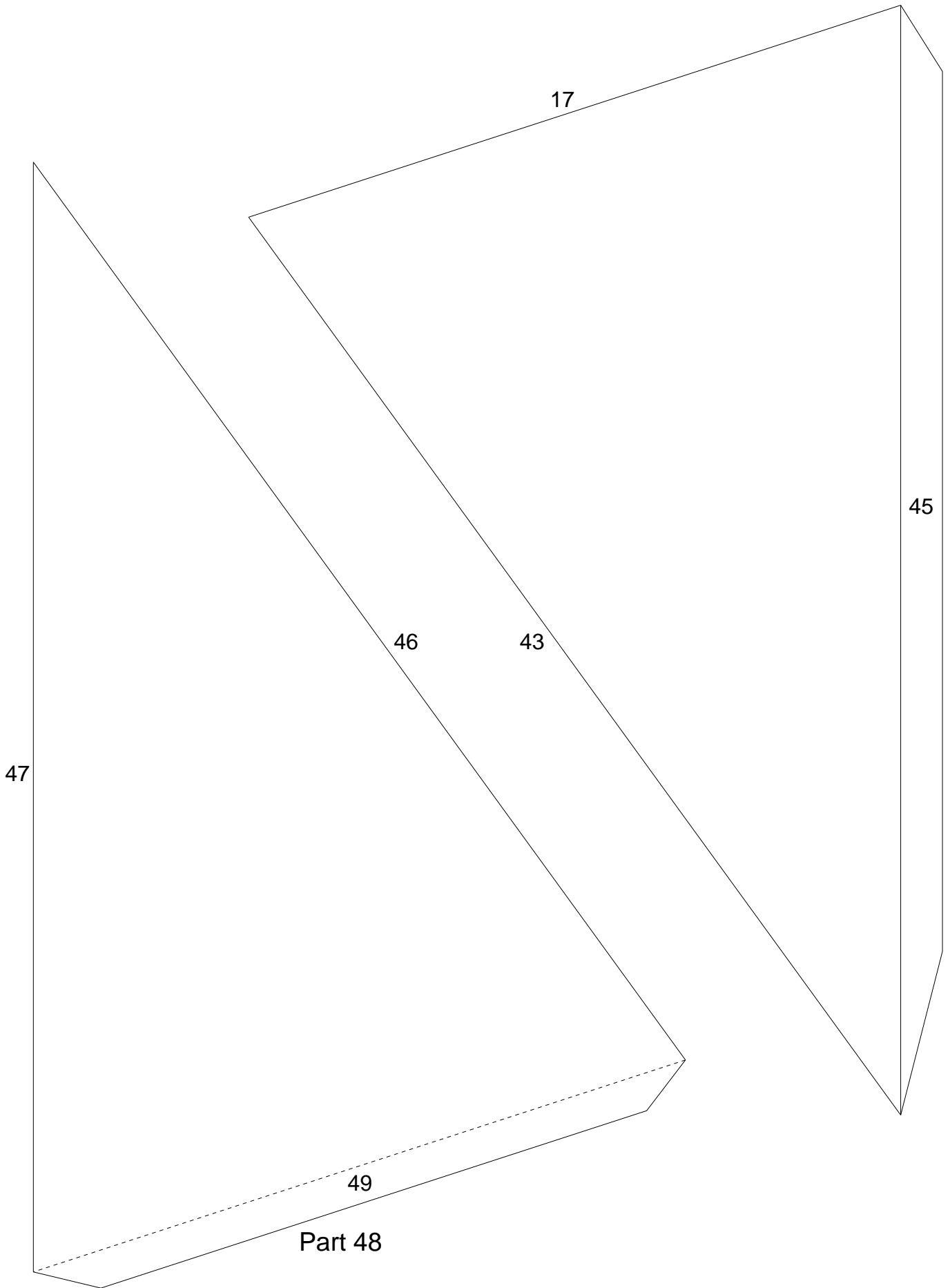

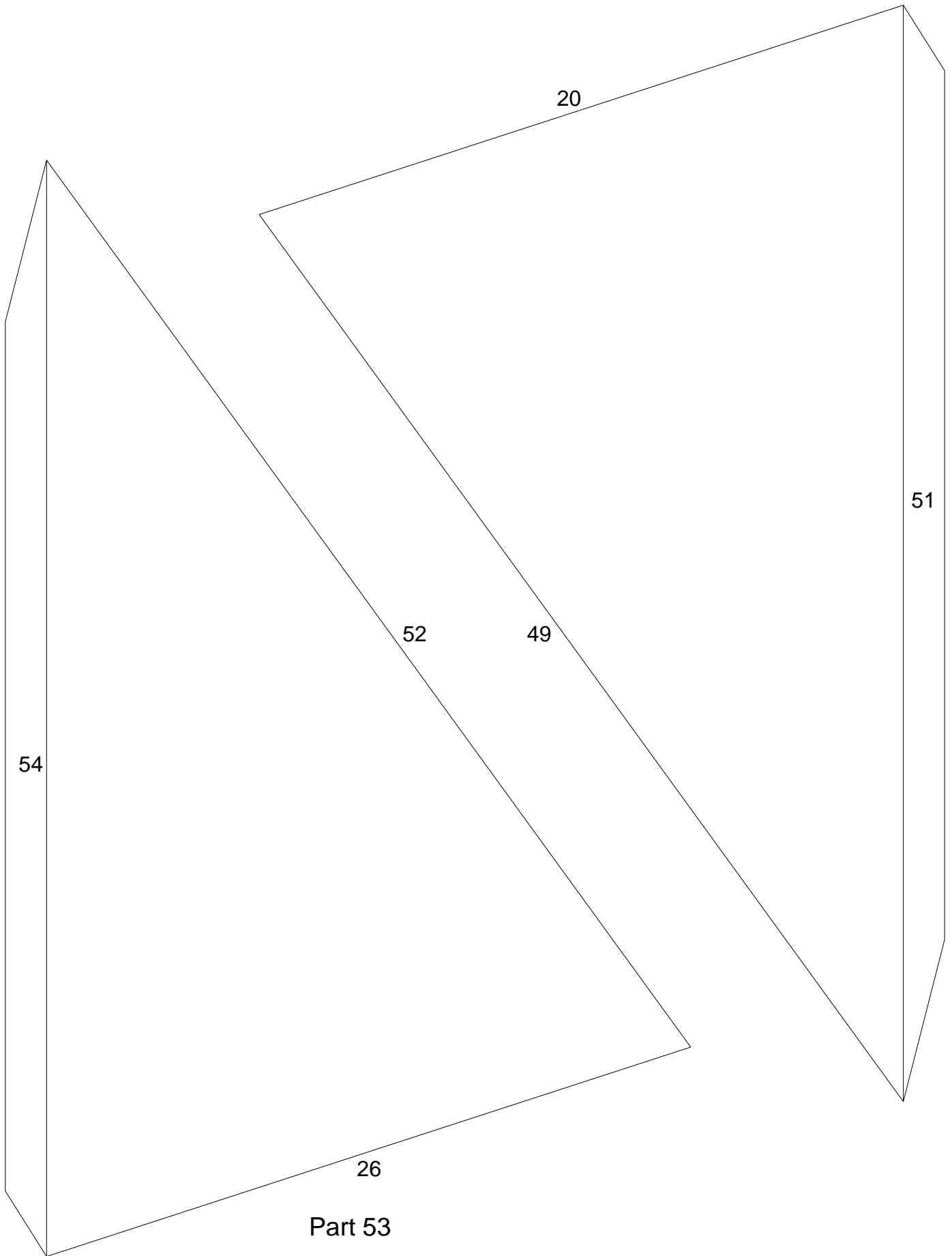

Part 53

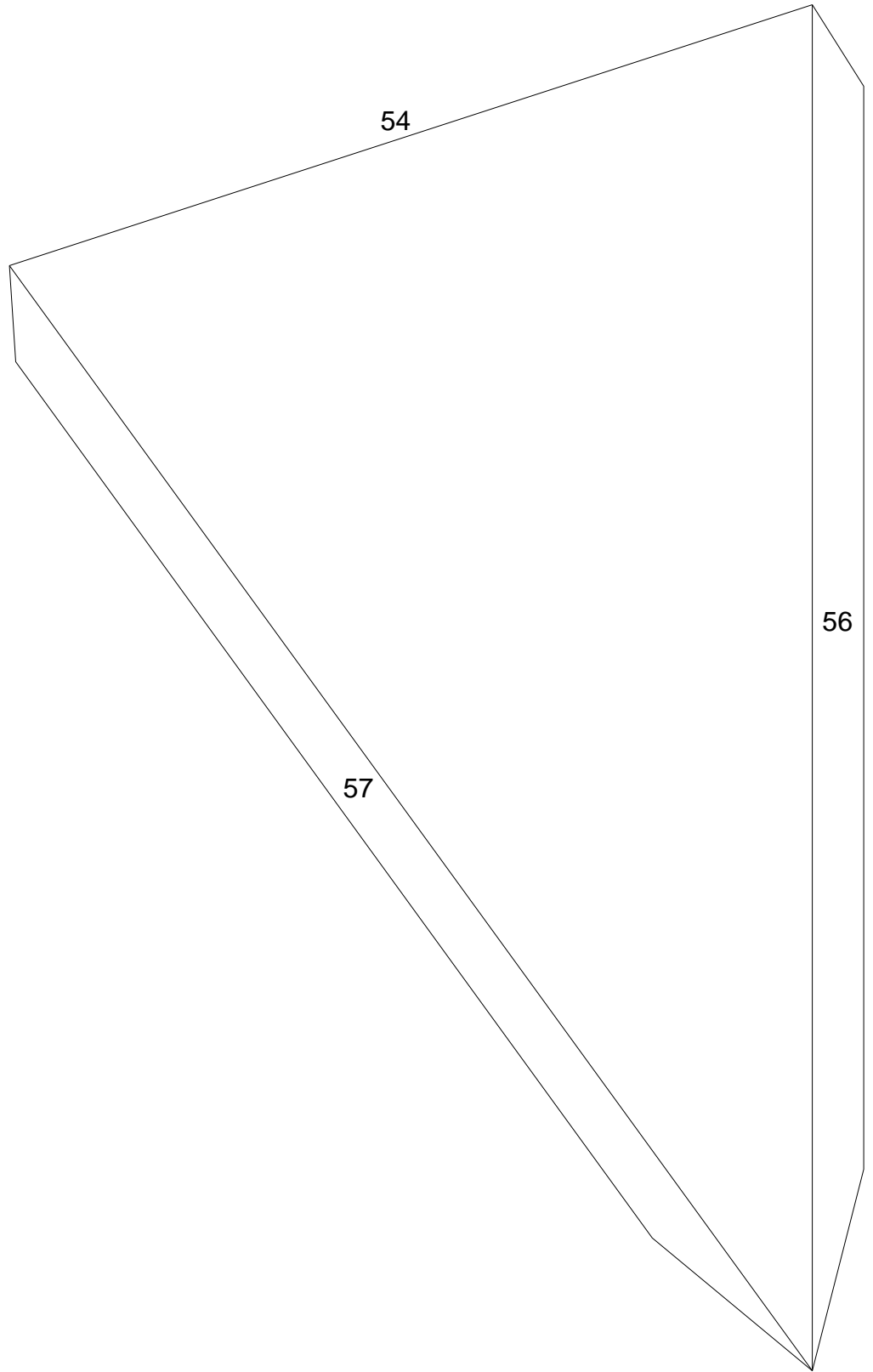

Great Stellated Dodecahedron

Color 2

Part 2

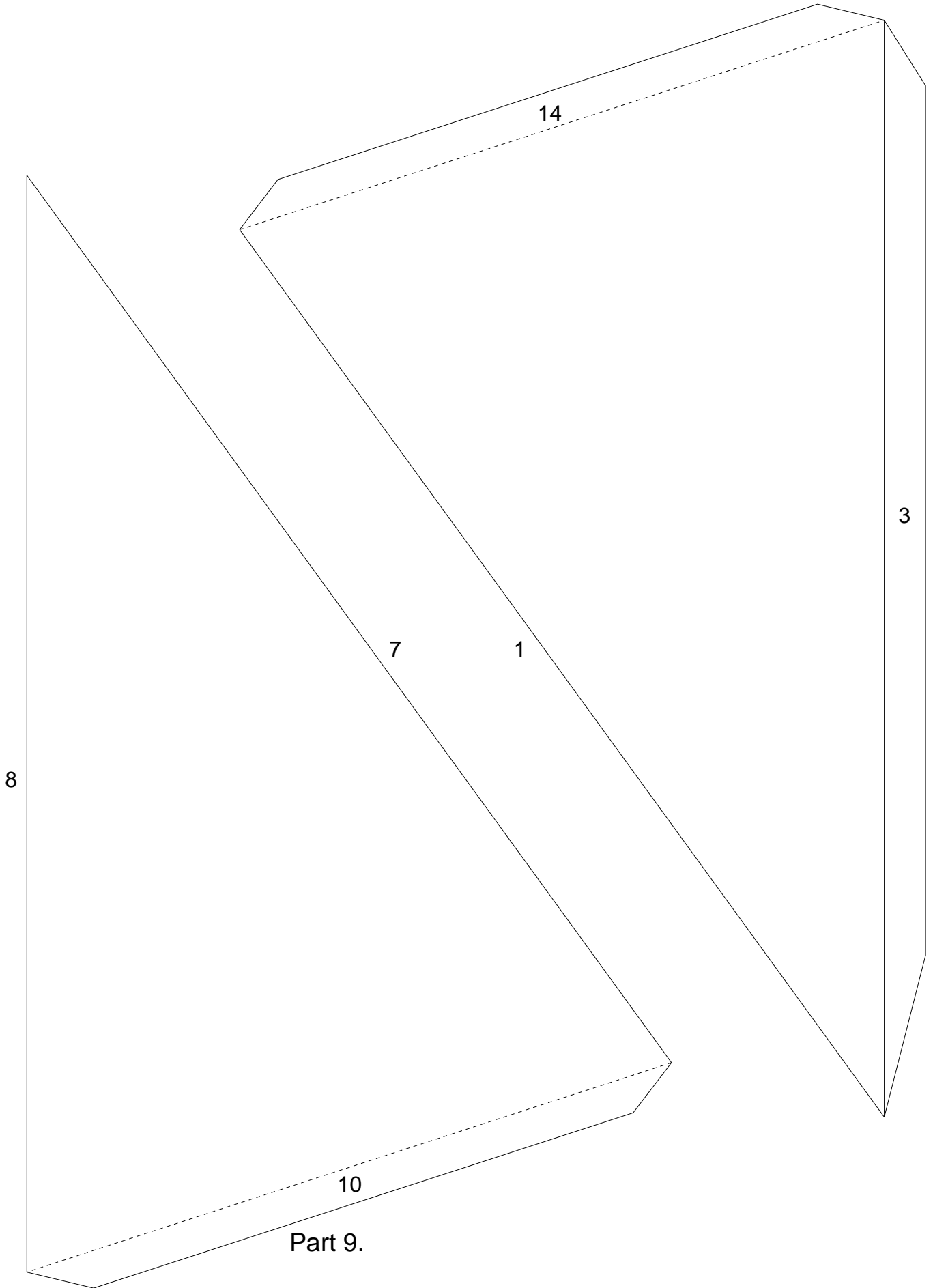

Great Stellated Dodecahedron

Color 2

Part 11

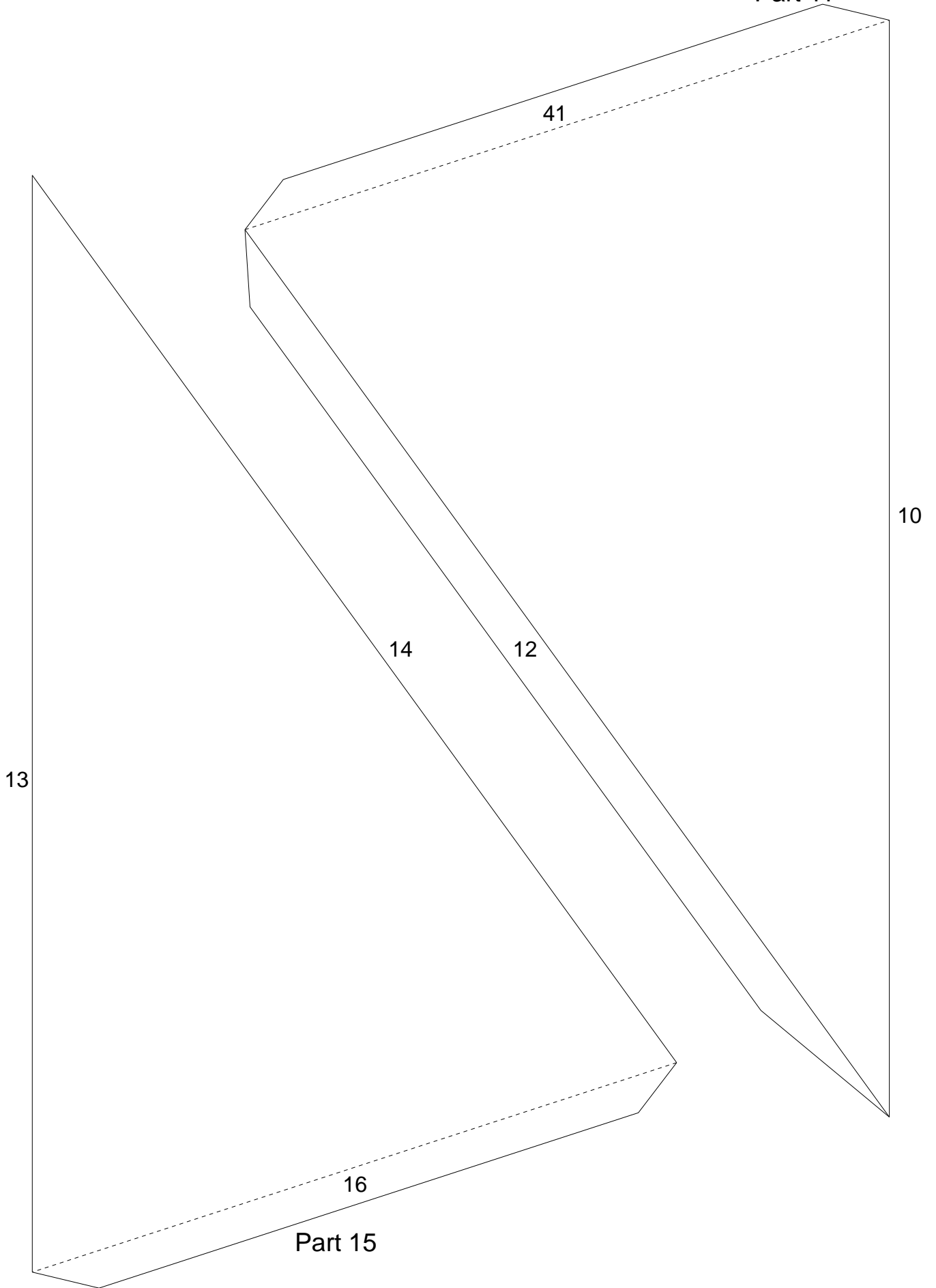

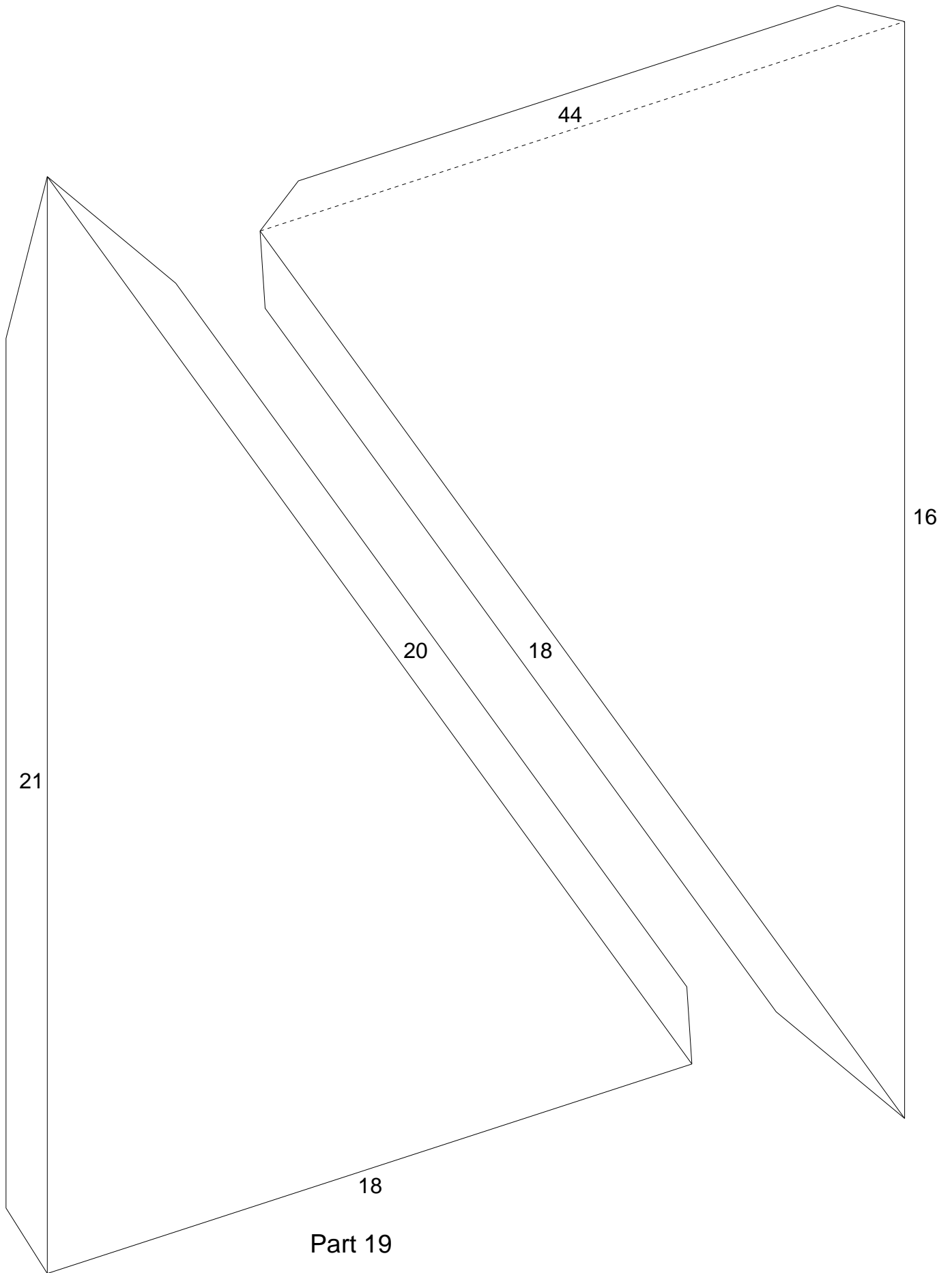

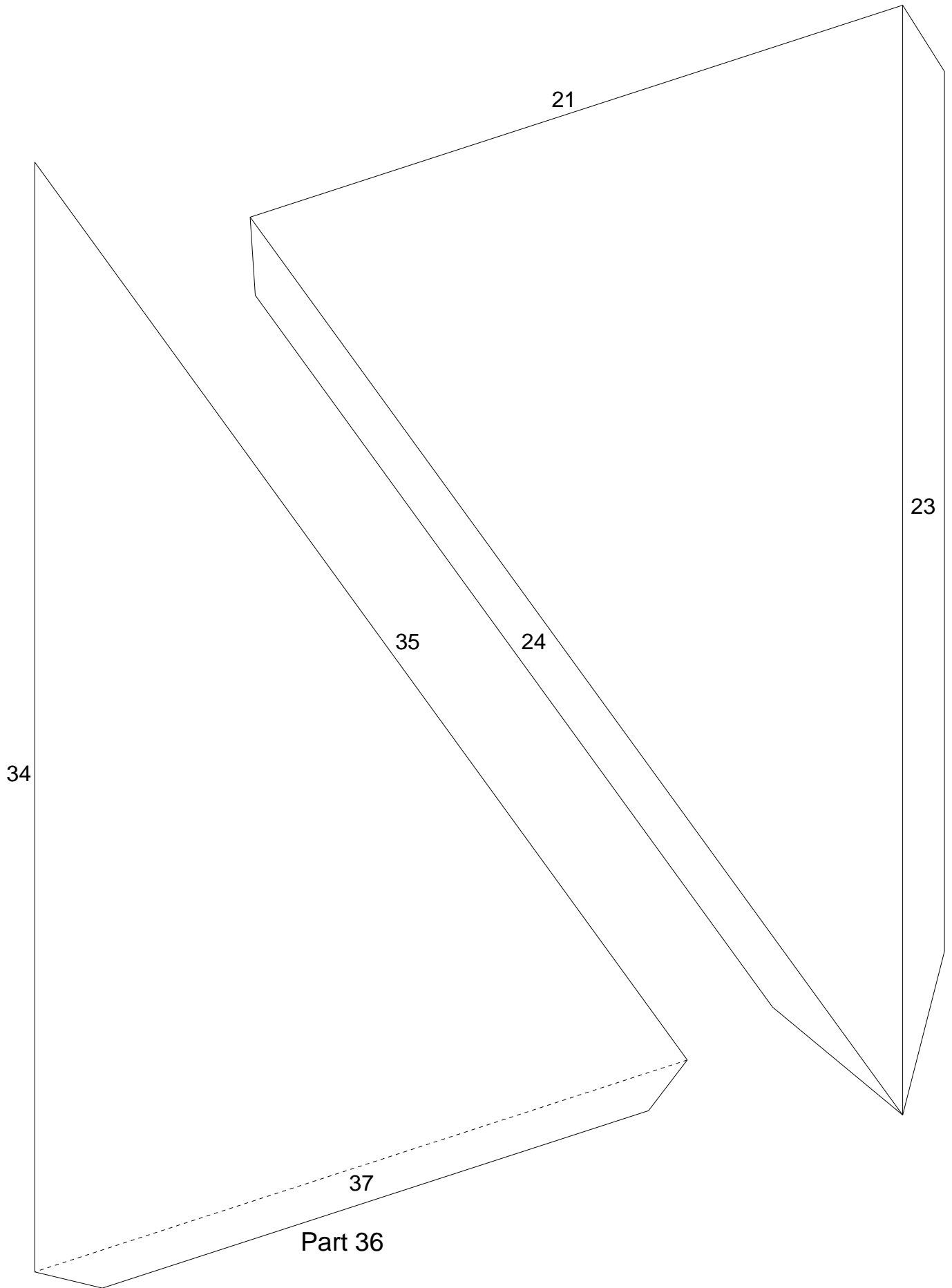

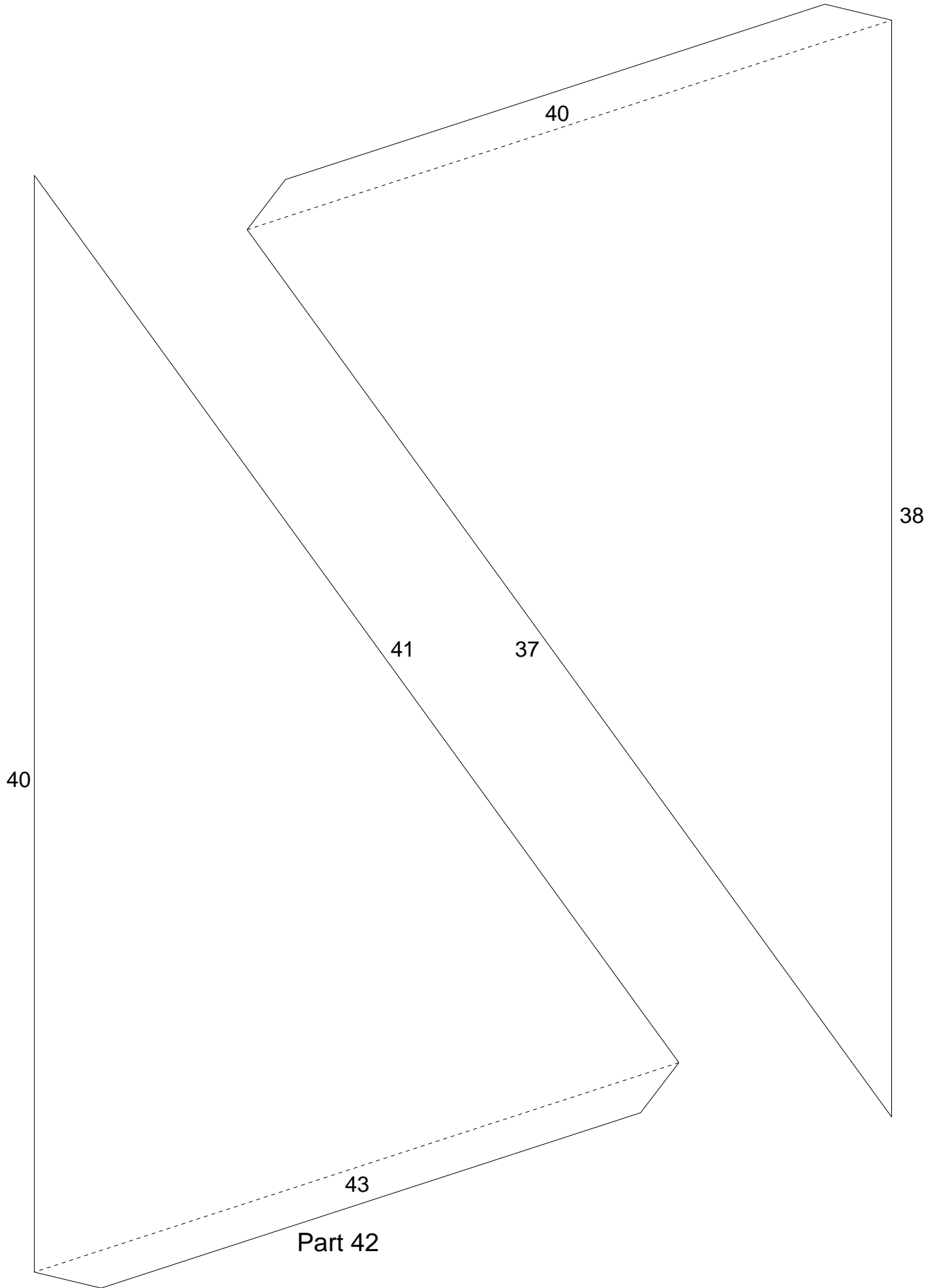

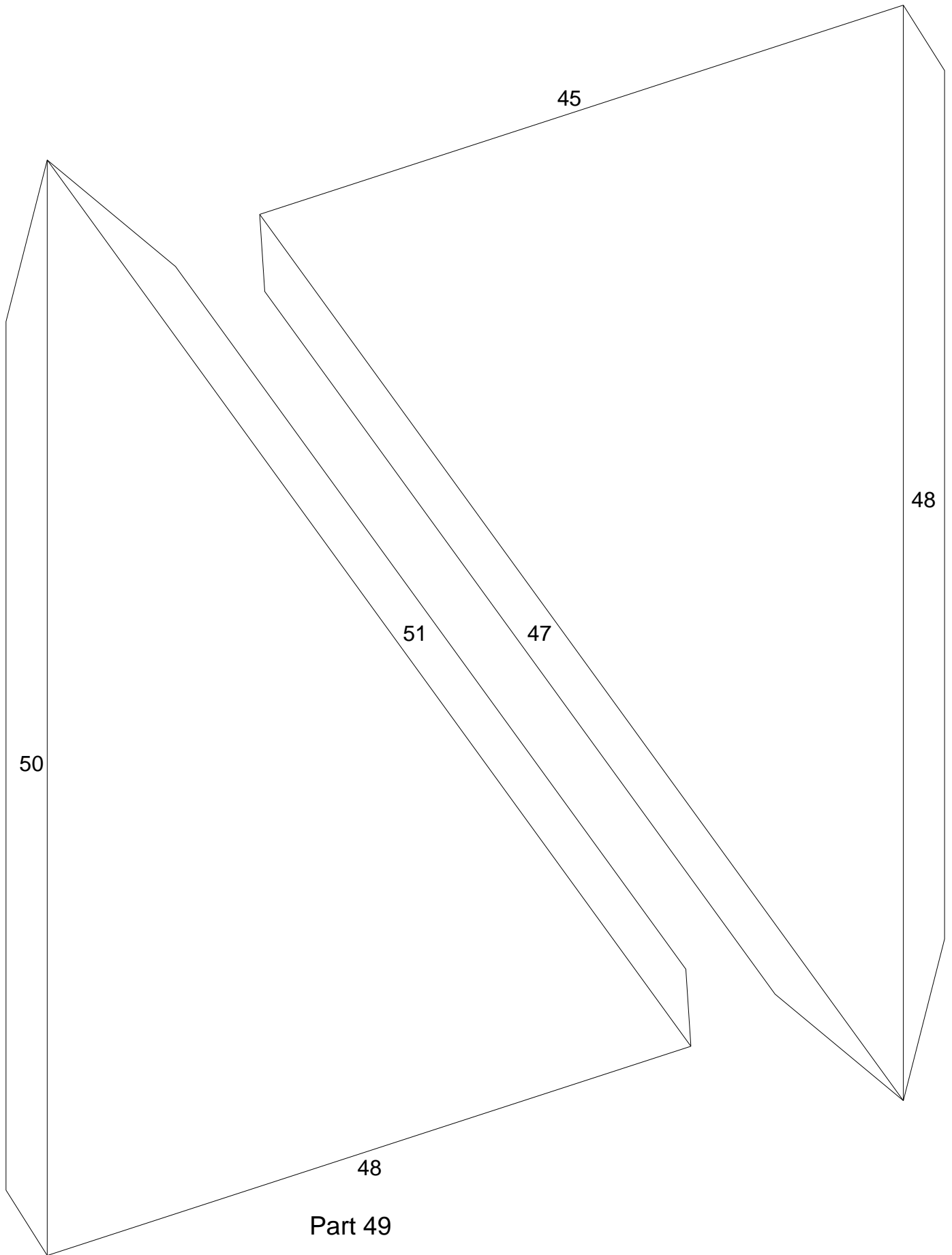

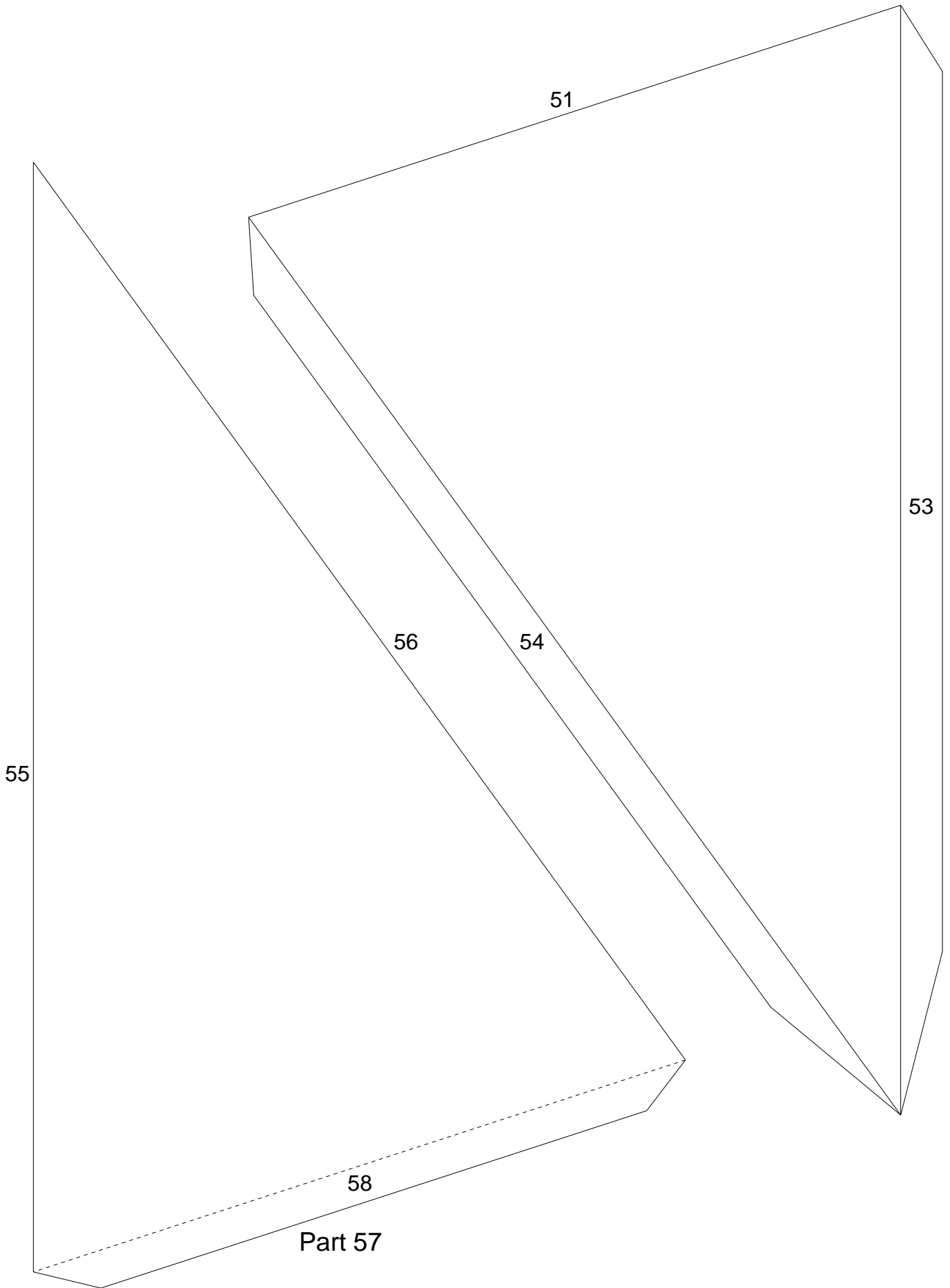

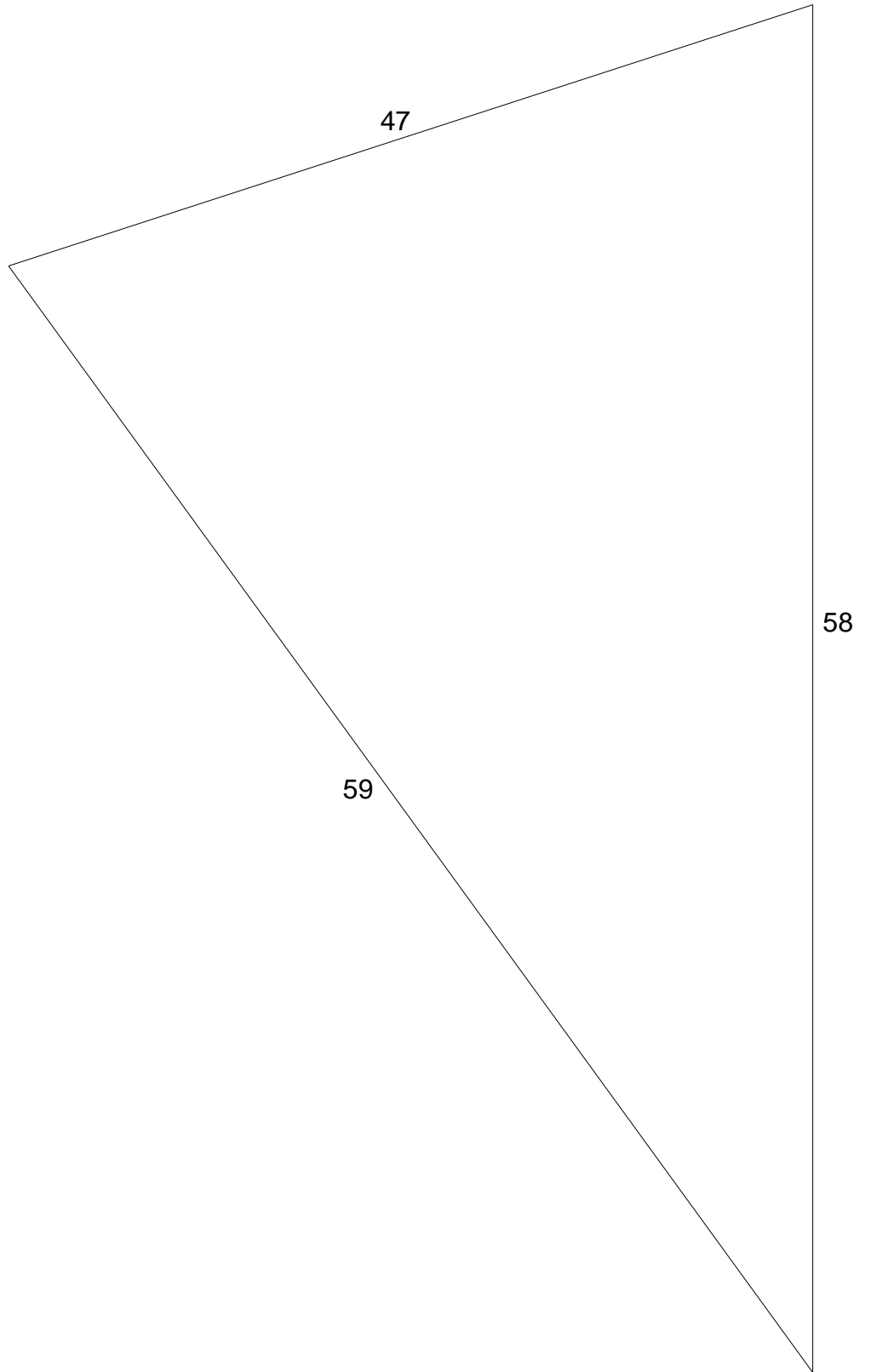

Great Stellated Dodecahedron

Color 3

Part 3

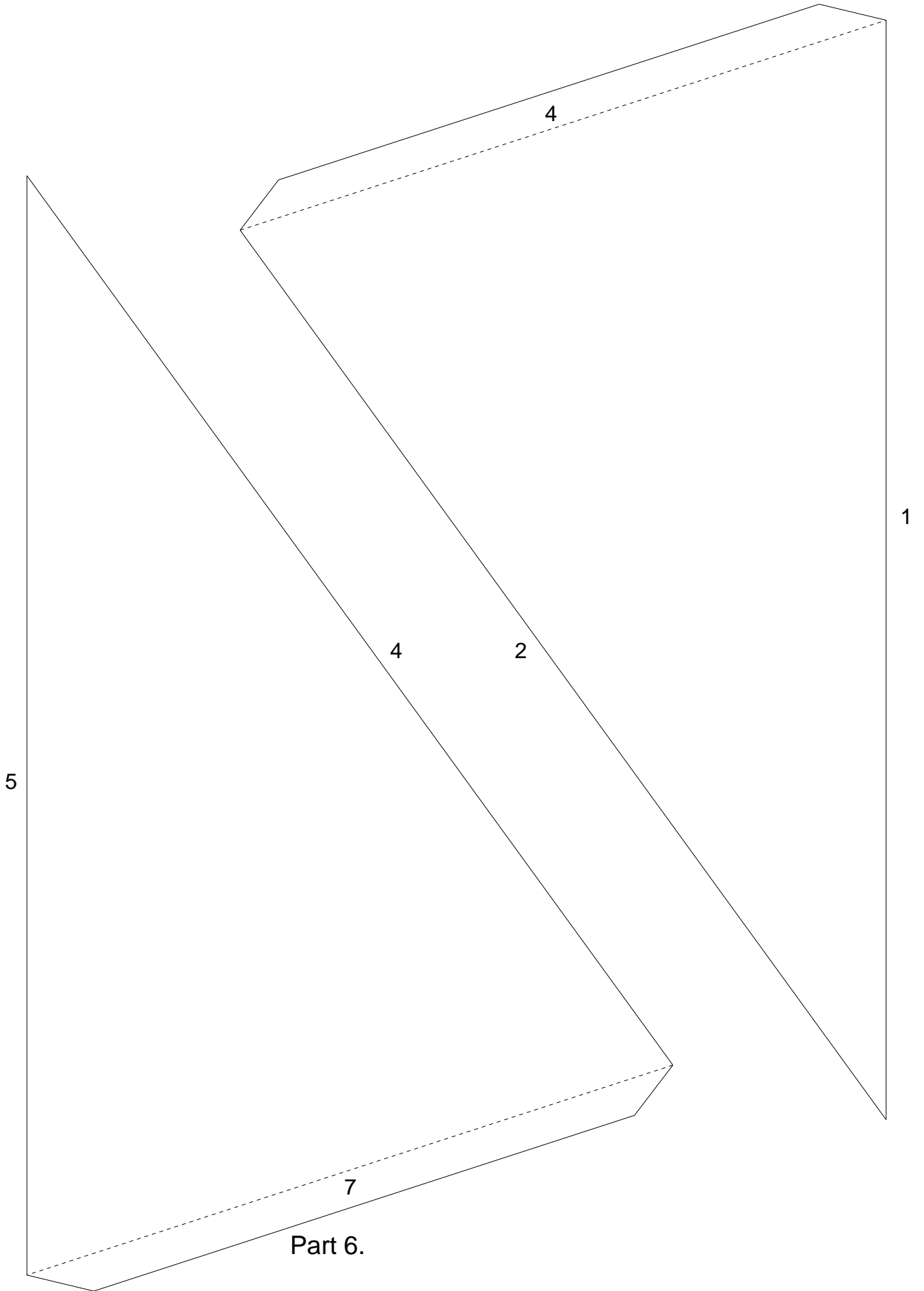

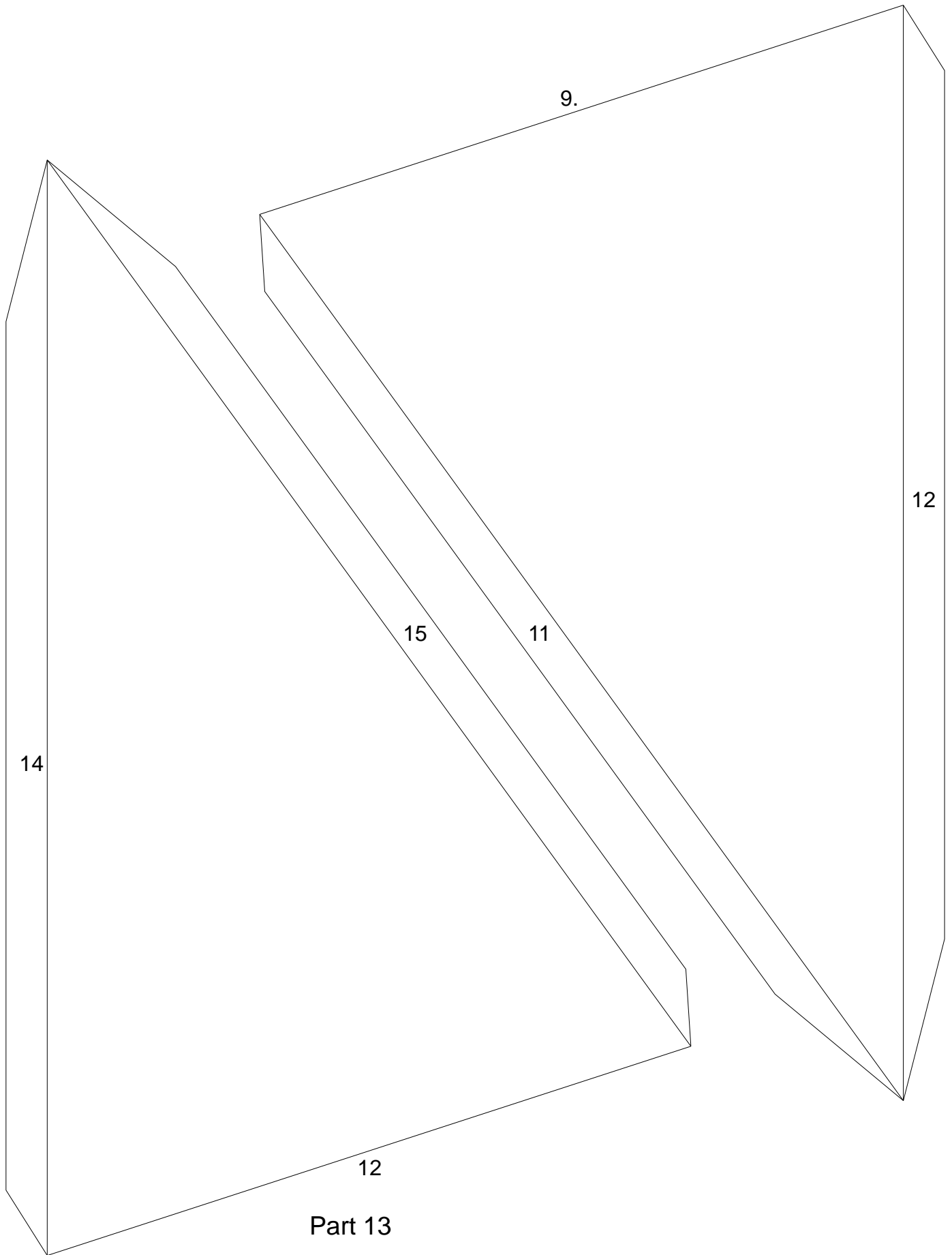

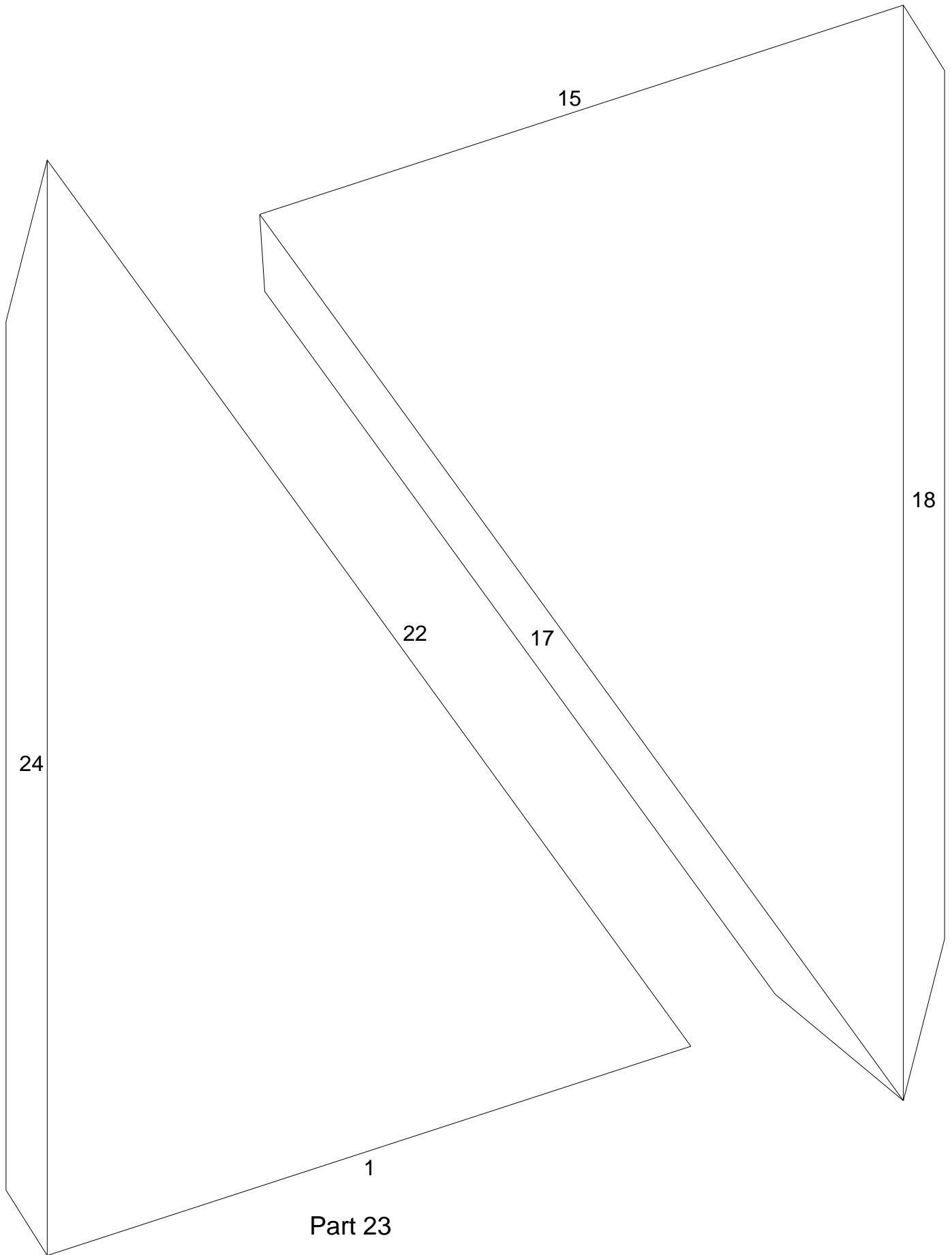

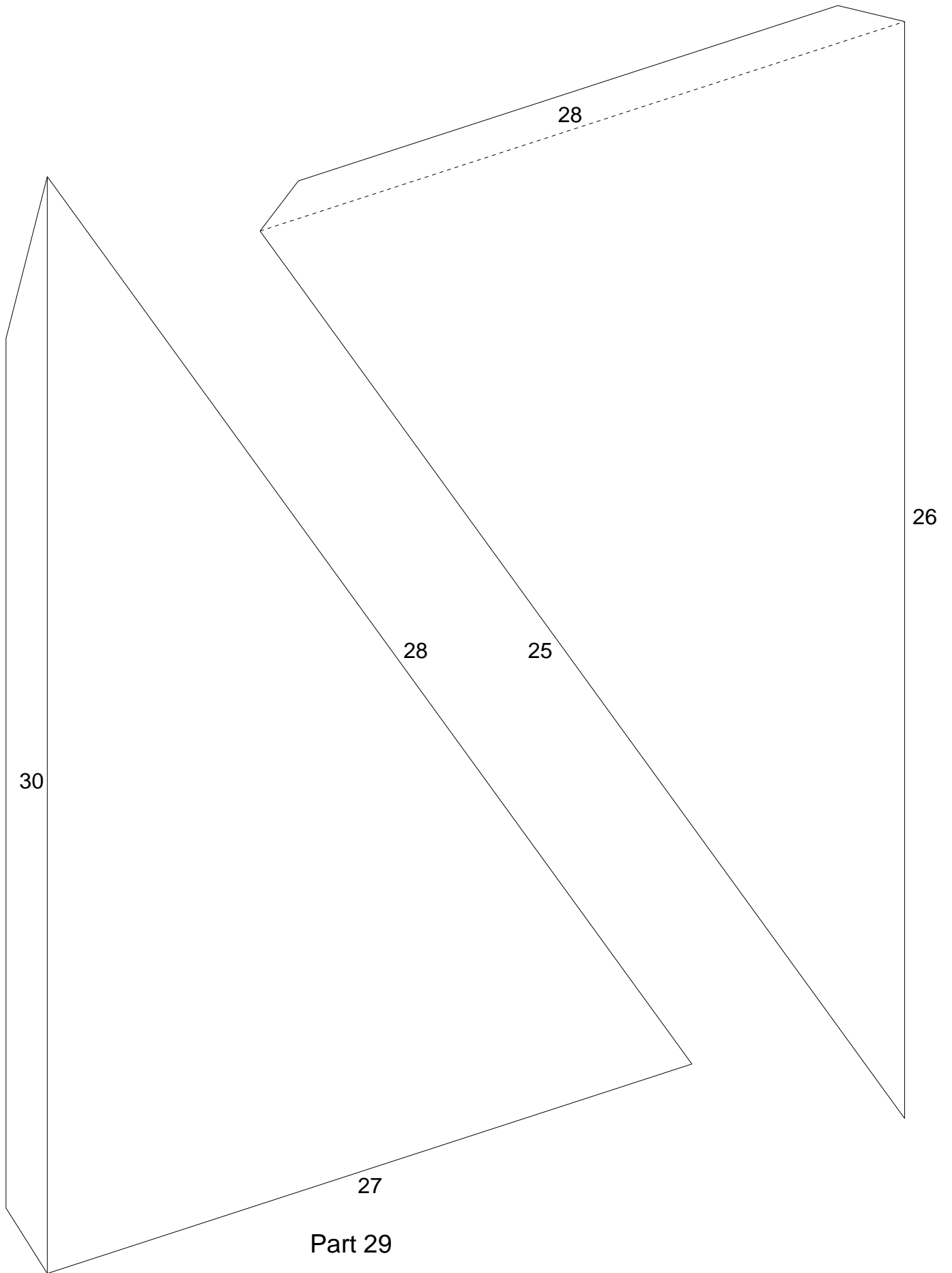

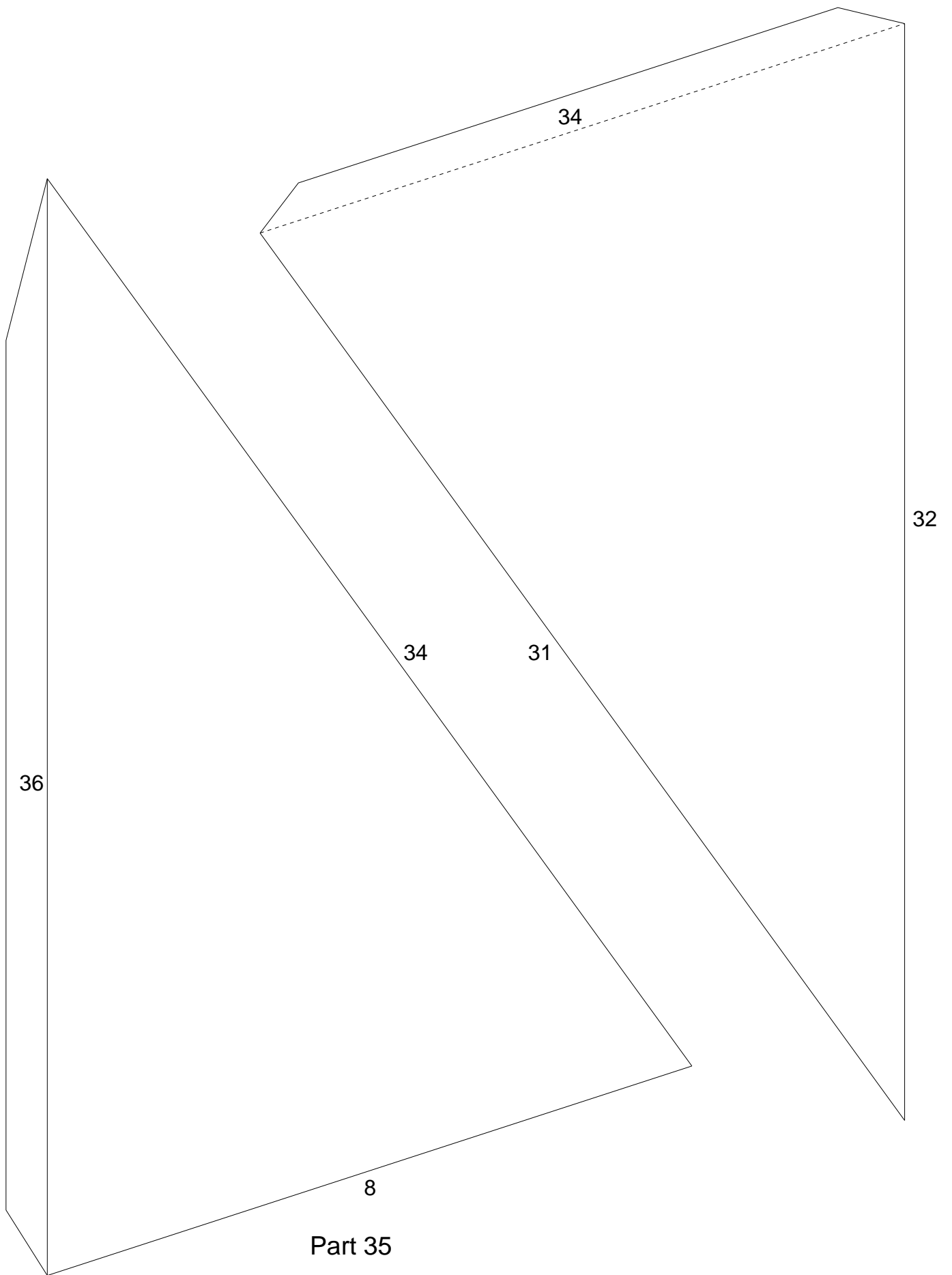

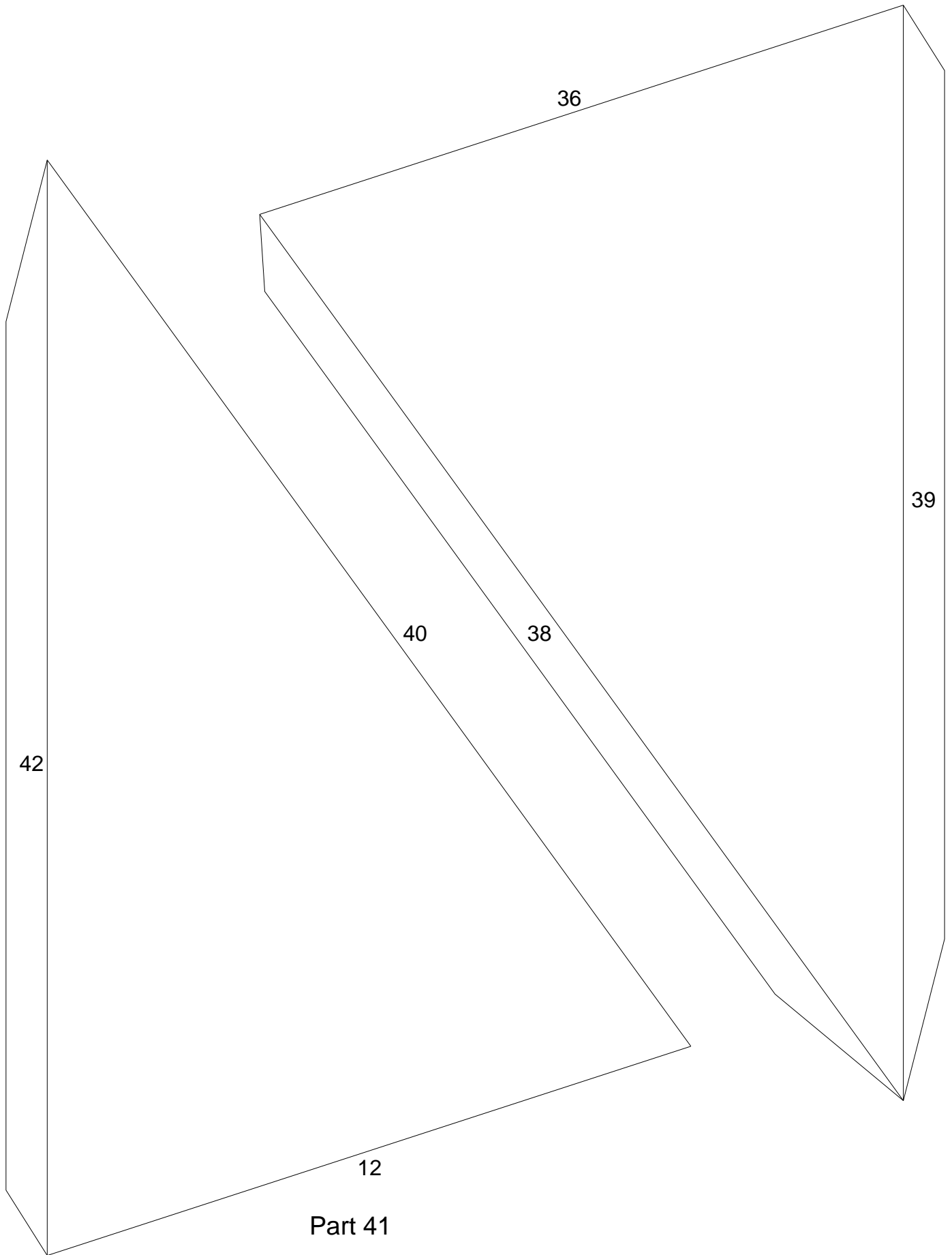

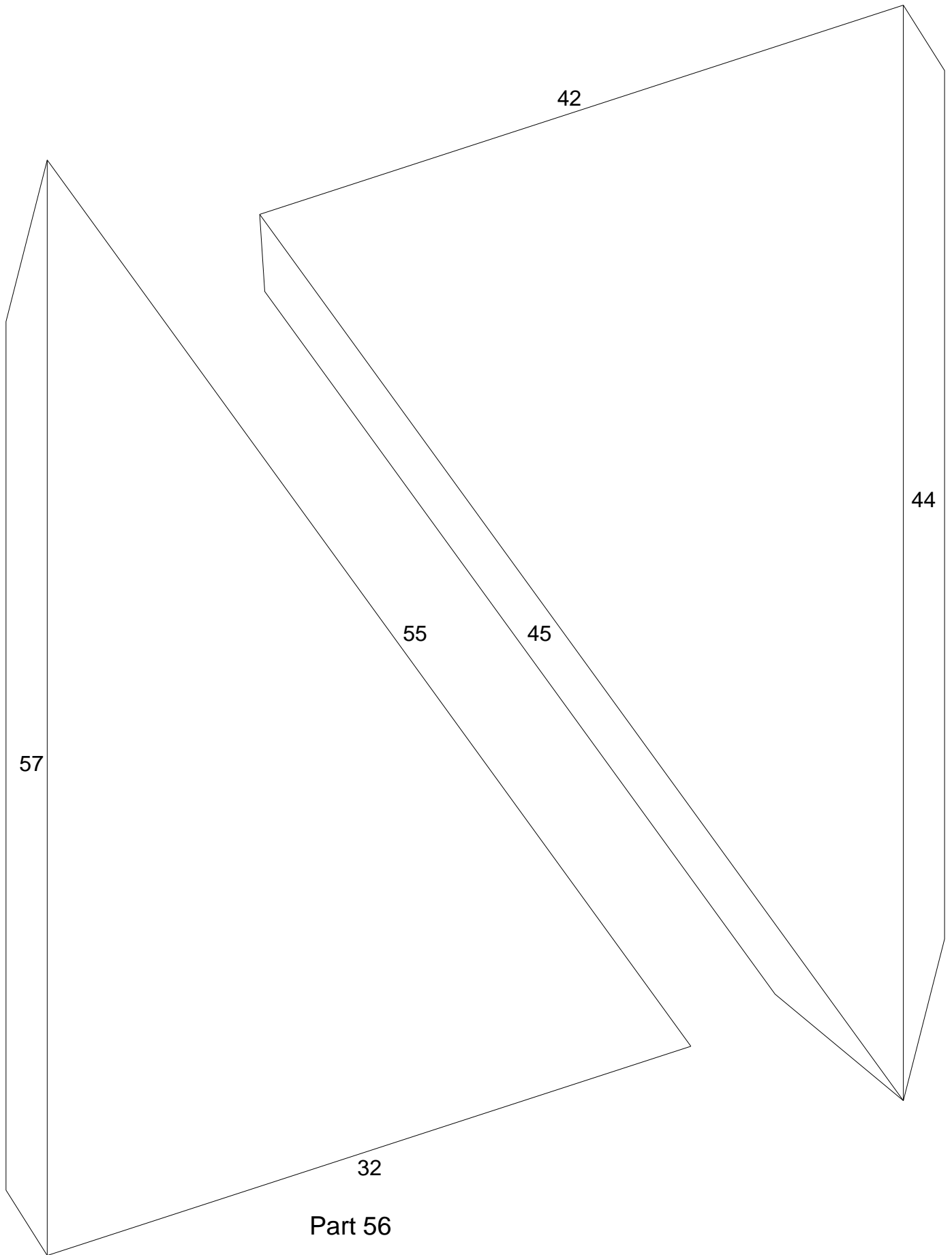

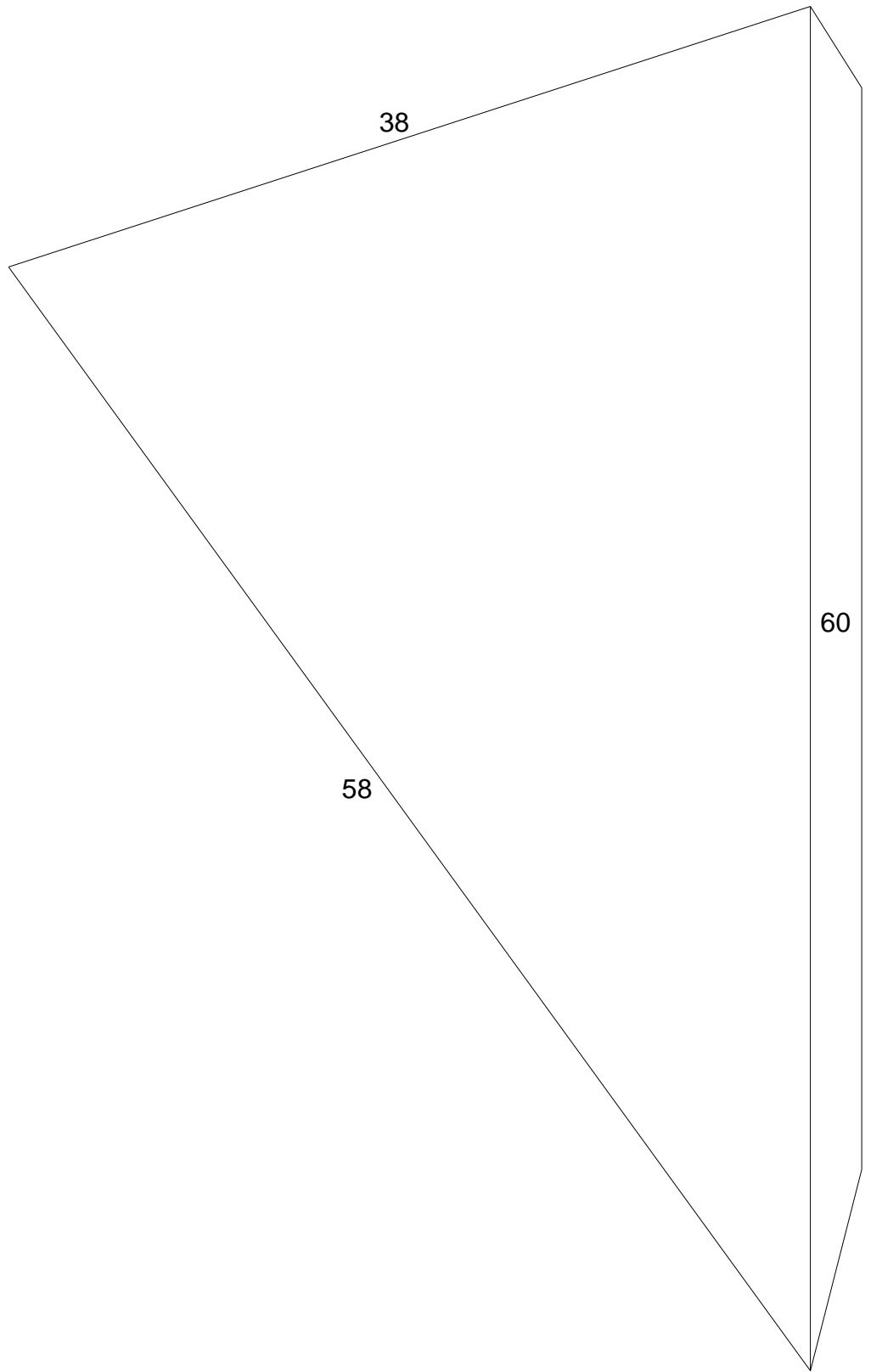

Great Stellated Dodecahedron

Color 4

Part 5

