

Paper Models of Polyhedra Collection 6 uncolored

Platonic Solids in two parts

Dodecahedron (3 versions)

Cube (3 versions)

Tetrahedron (2 versions)

Icosahedron (2 versions)

Octahedron (2 versions)

Copyrights © 2007 Gijs Korthals Altes

All rights reserved .

<http://www.korthalsaltes.com>

Email: inf@korthalsaltes.com

Dodecahedron divide in two parts

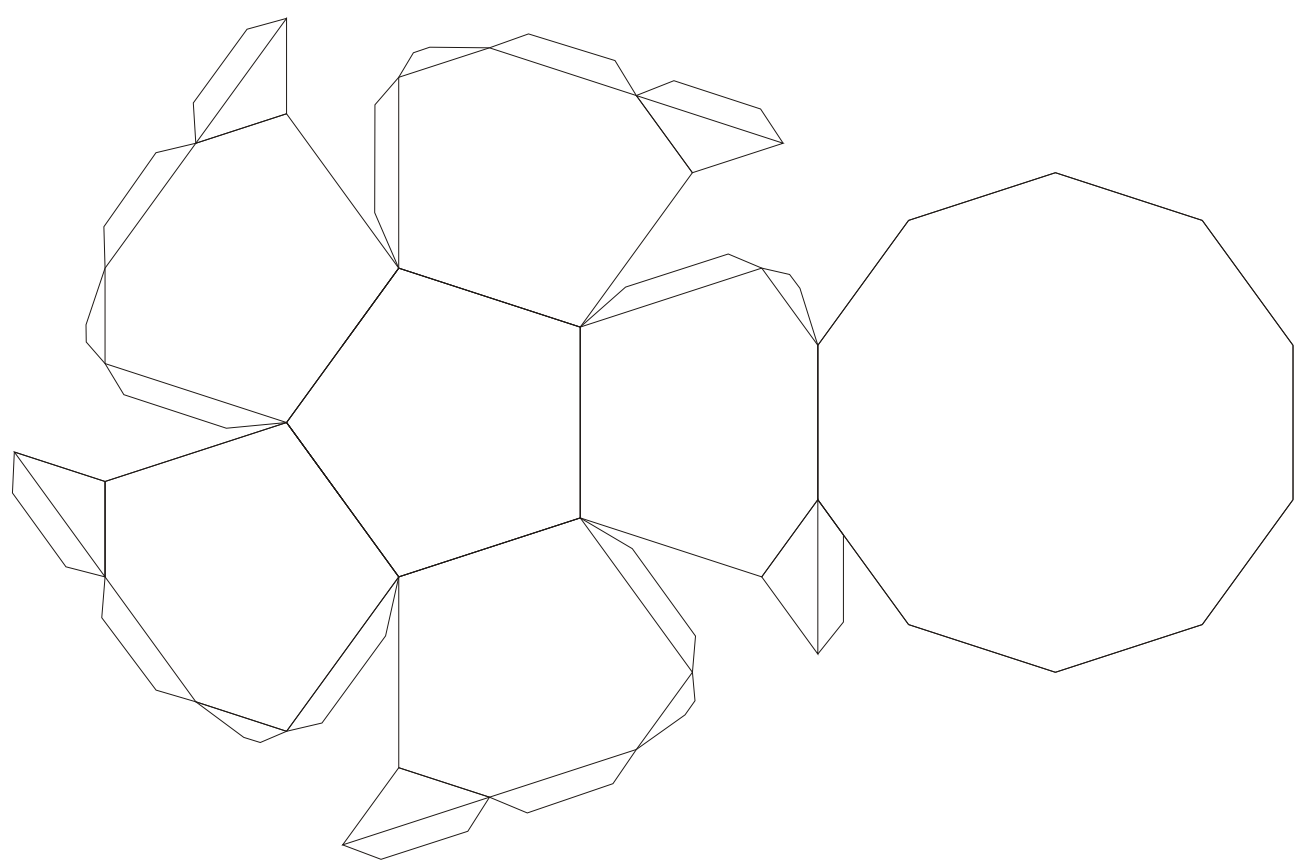
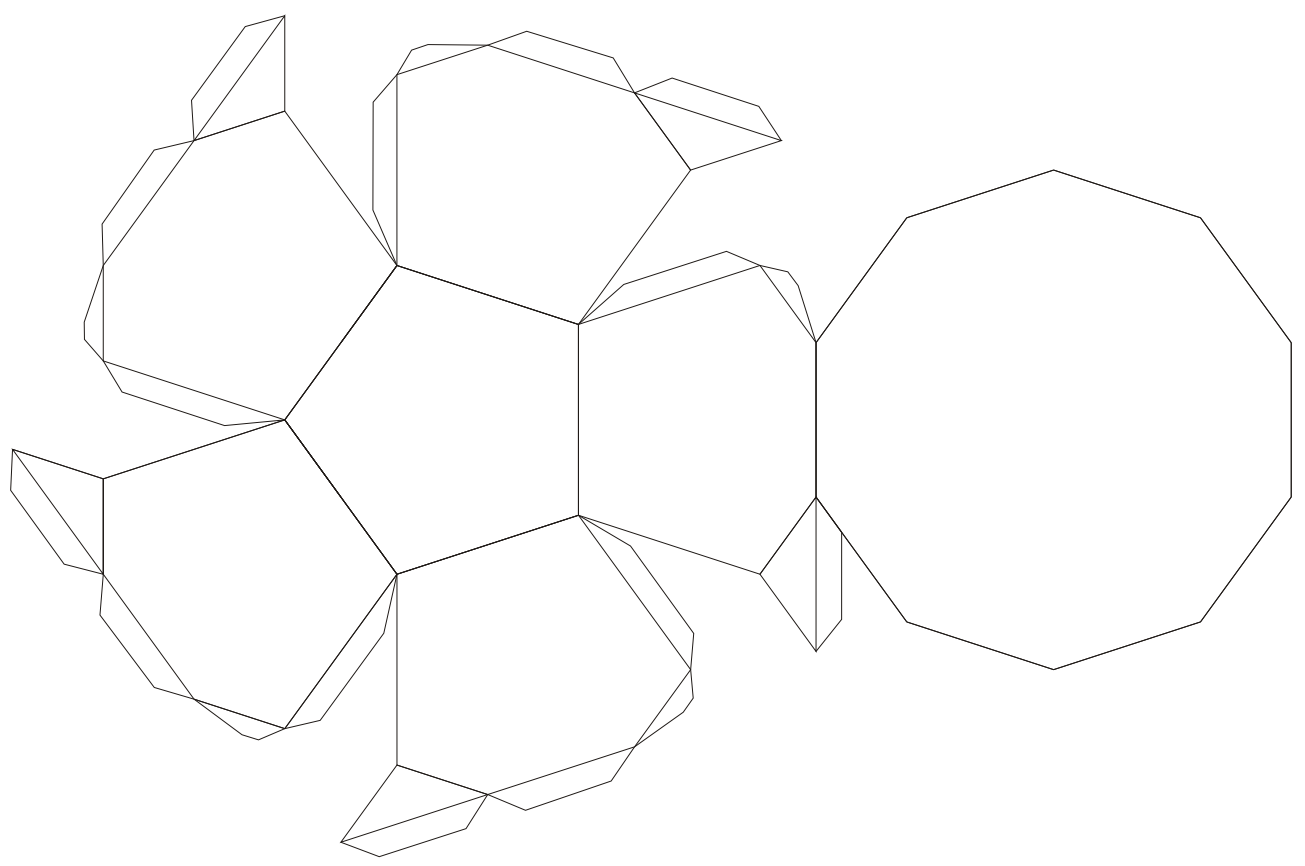

Dodecahedron divide in two parts

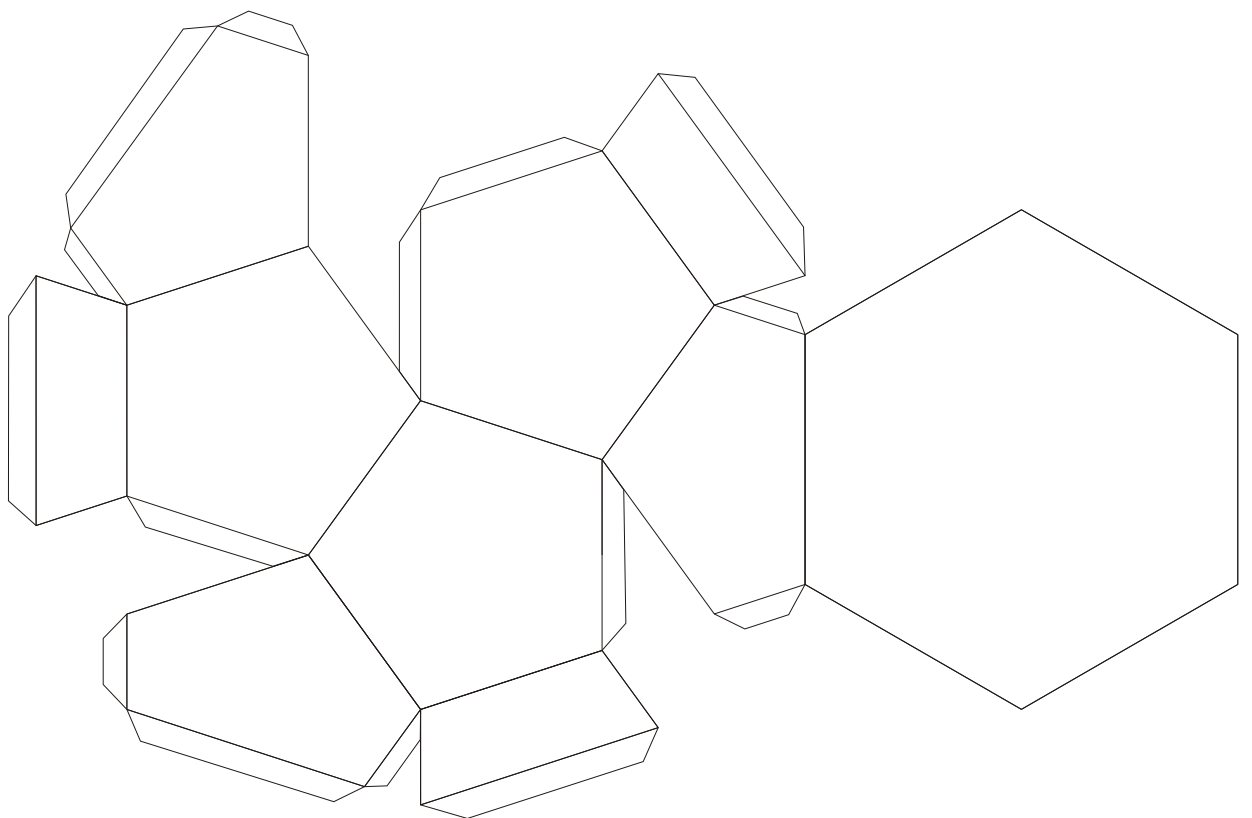
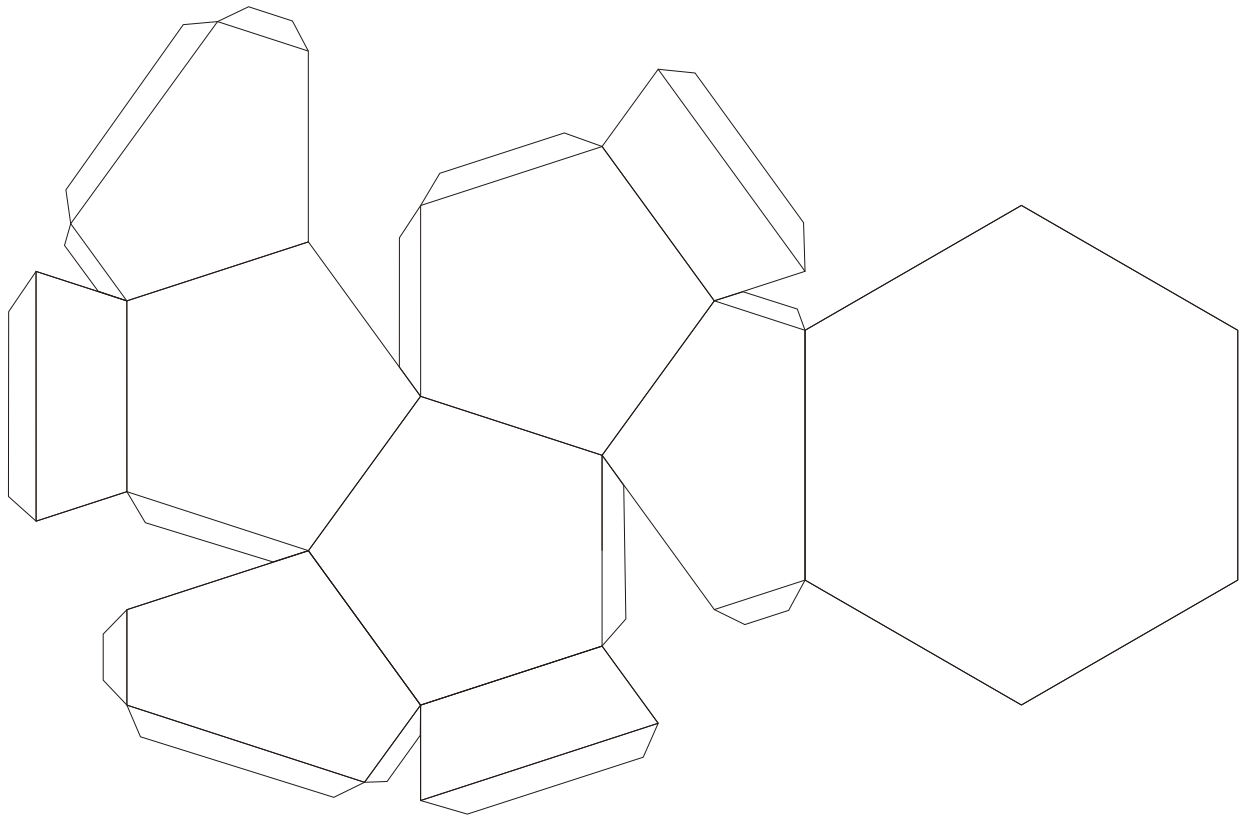

Dodecahedron divide in two parts

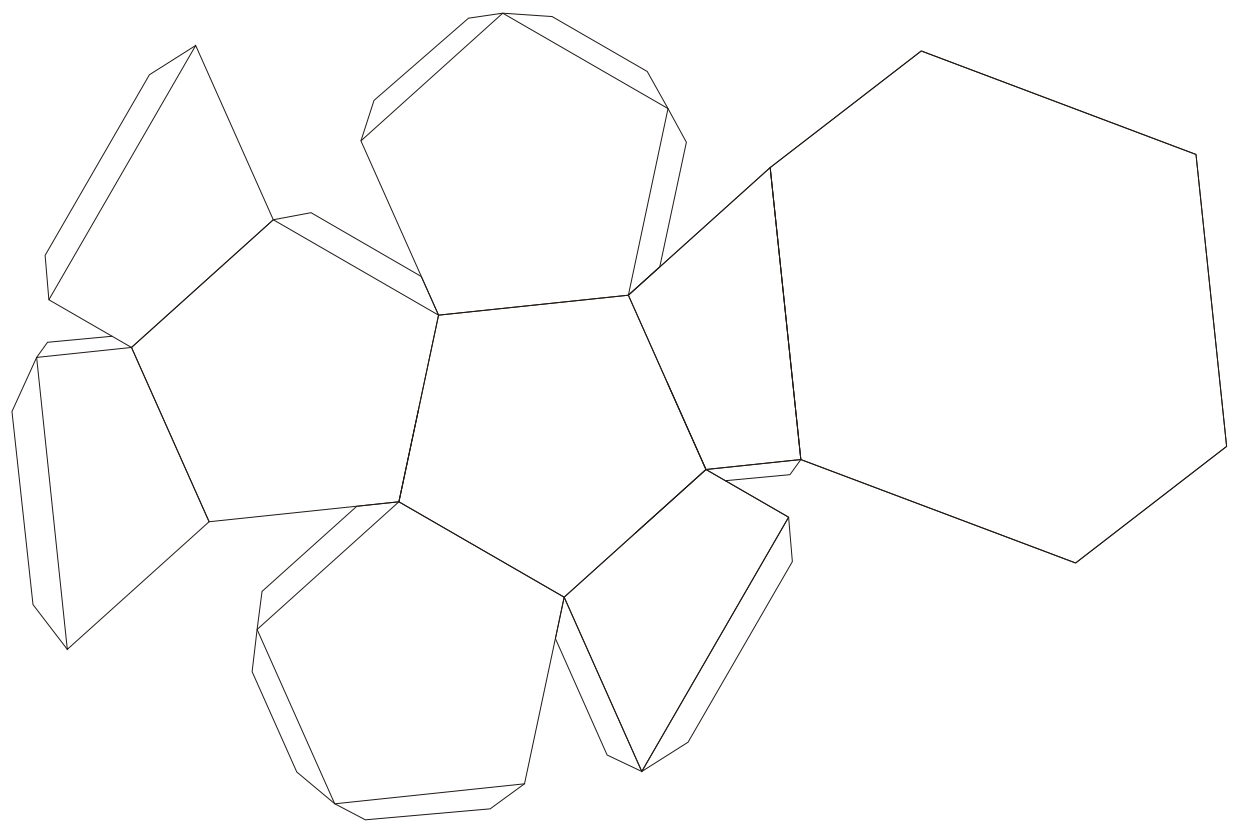
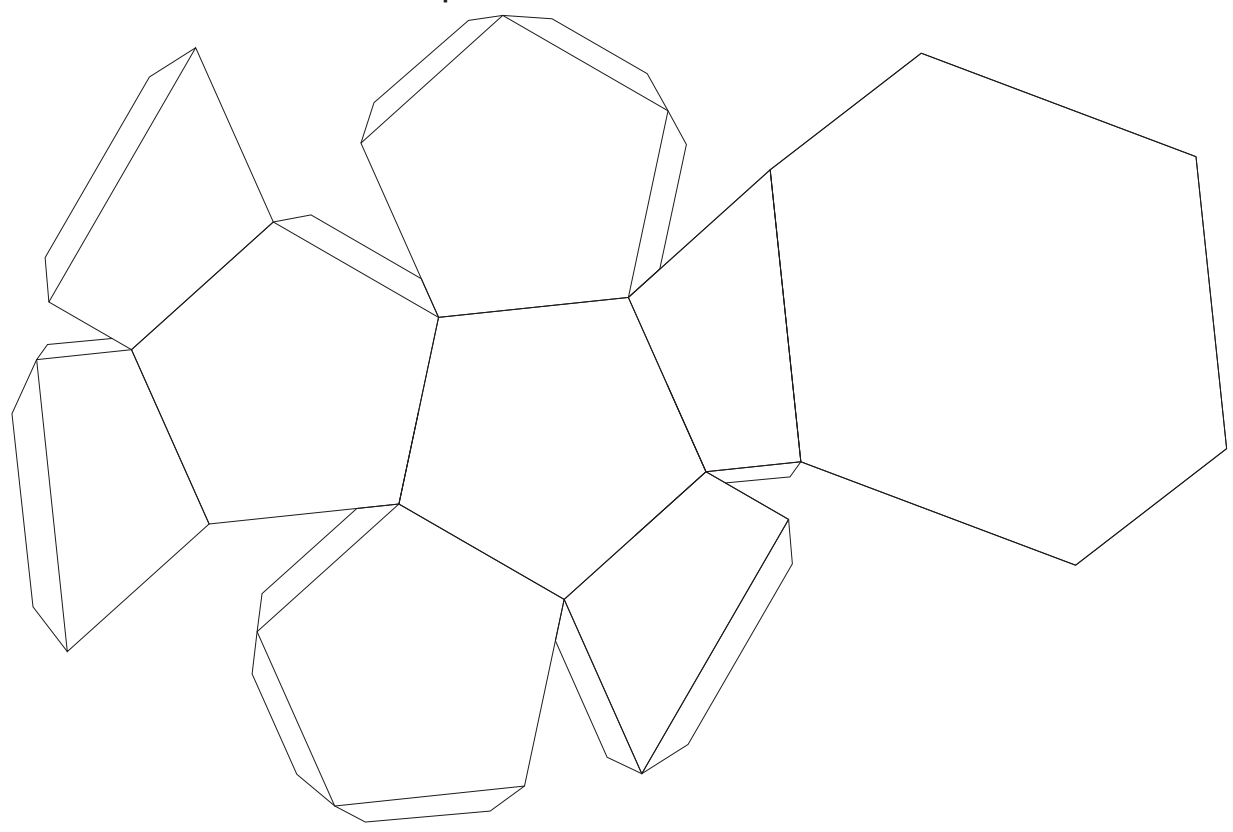

Cube

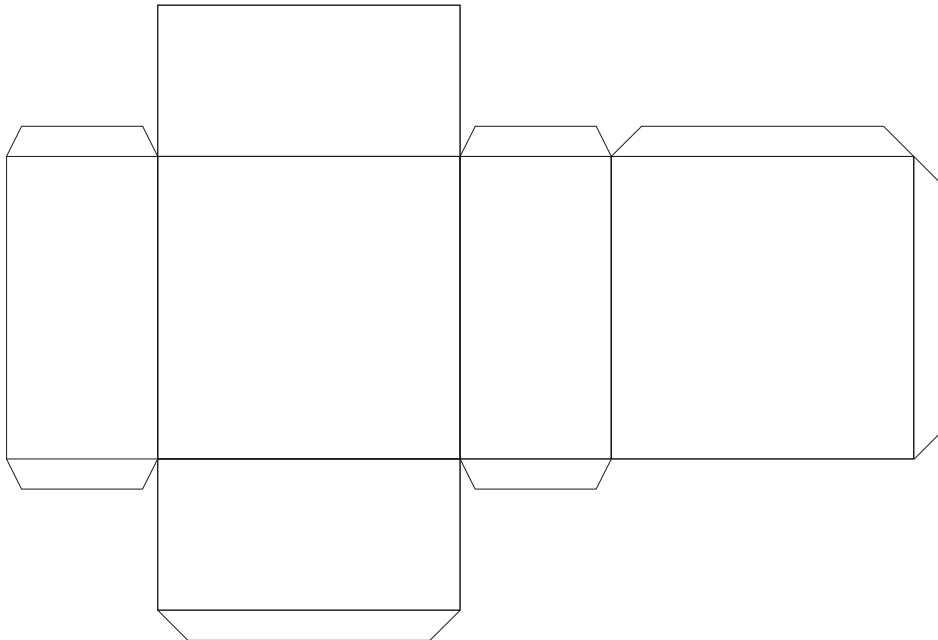
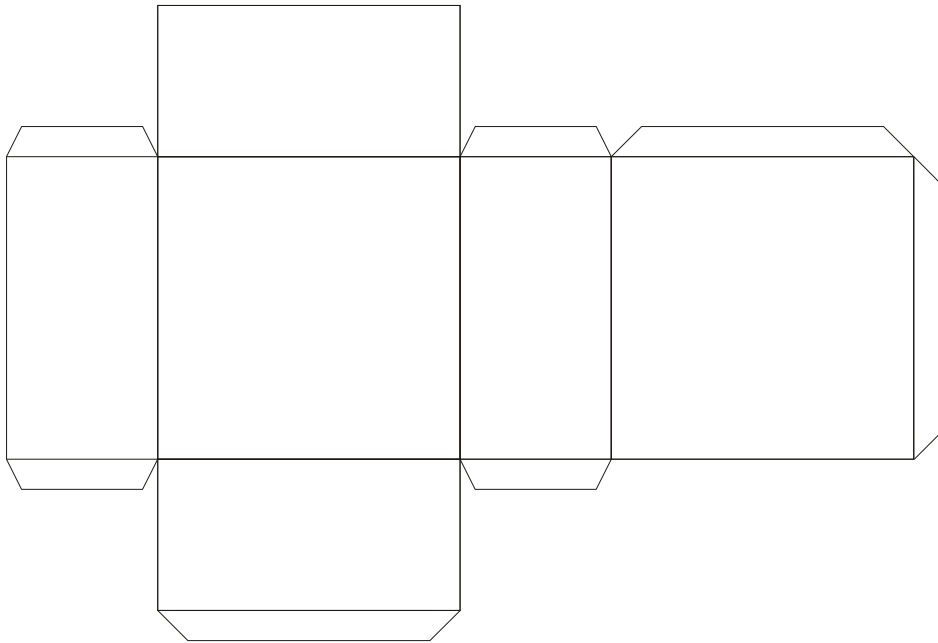

Cube

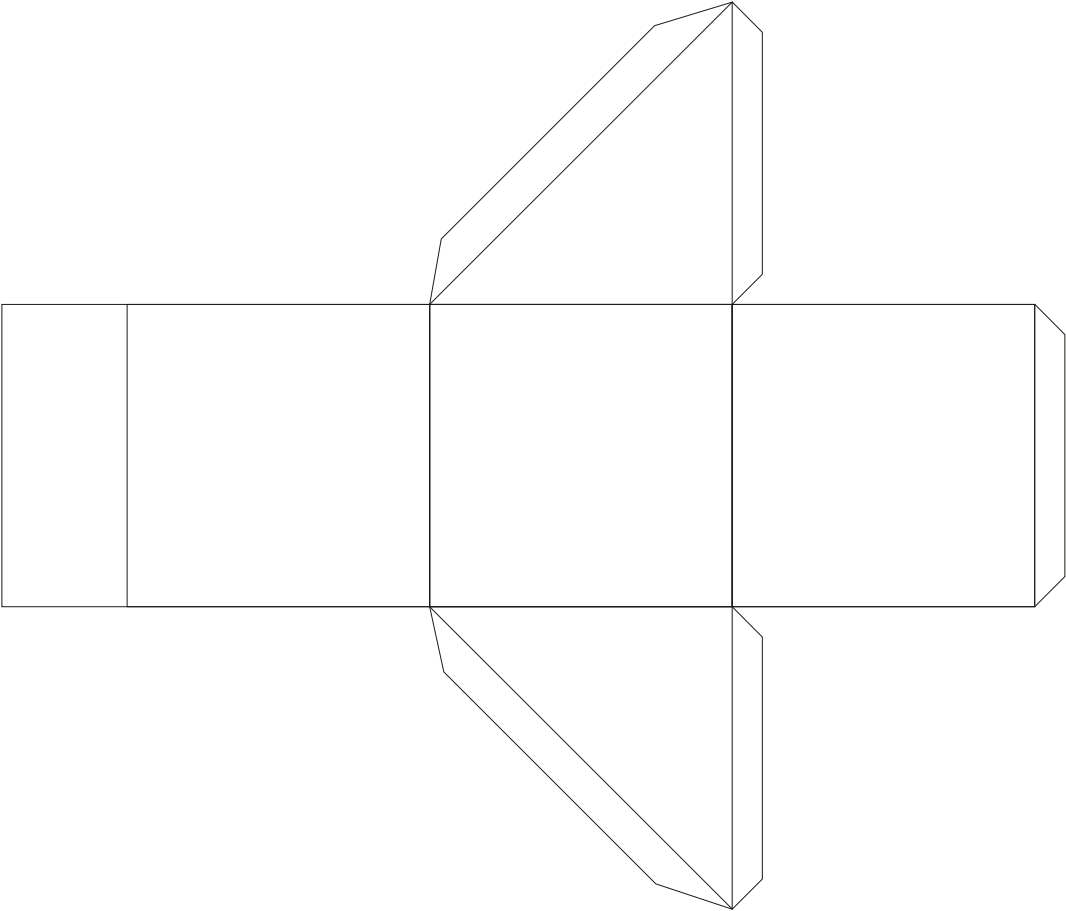
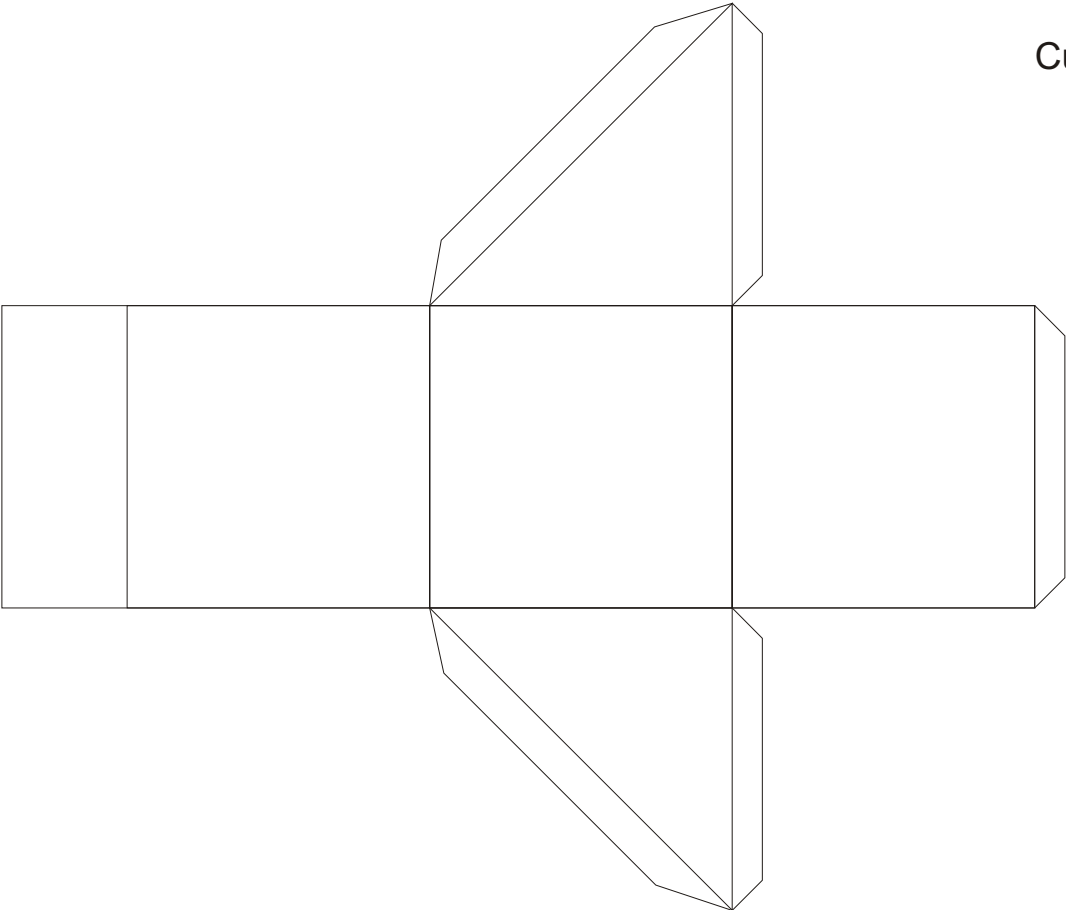

Cube

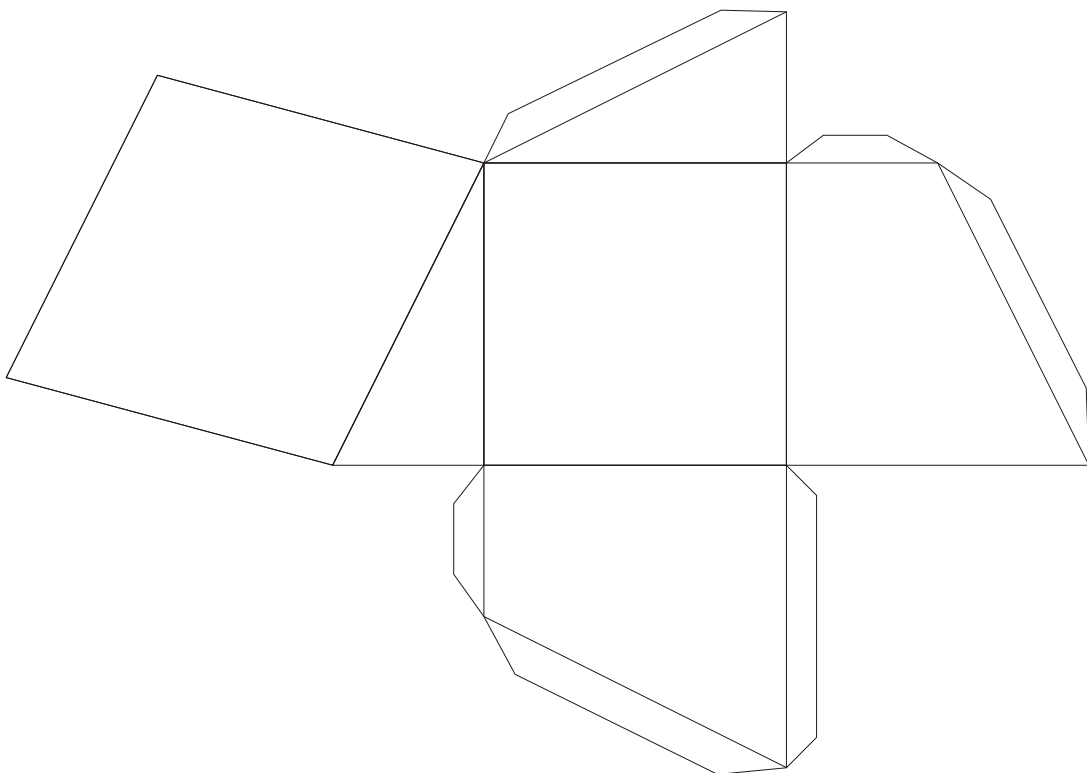
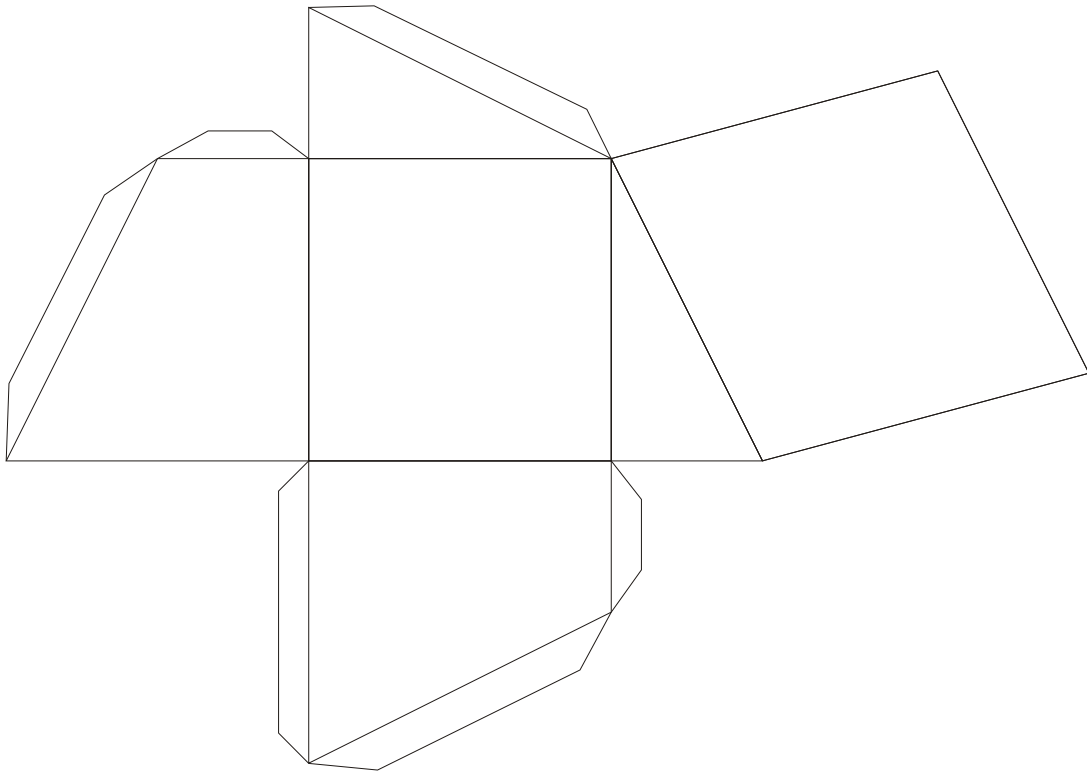

Tetrahedron

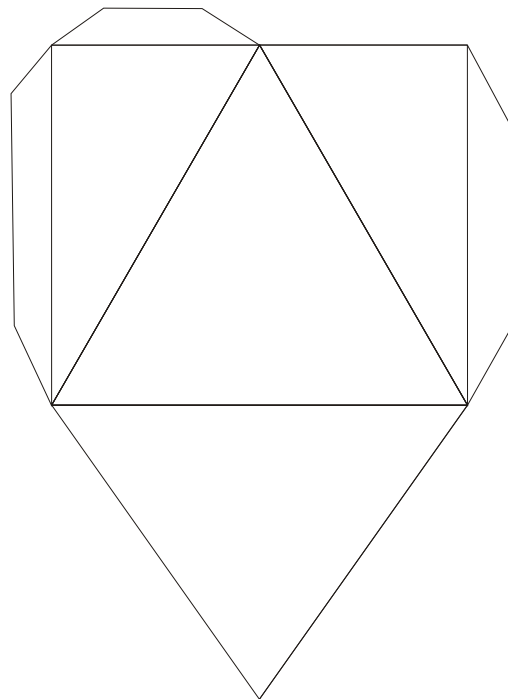
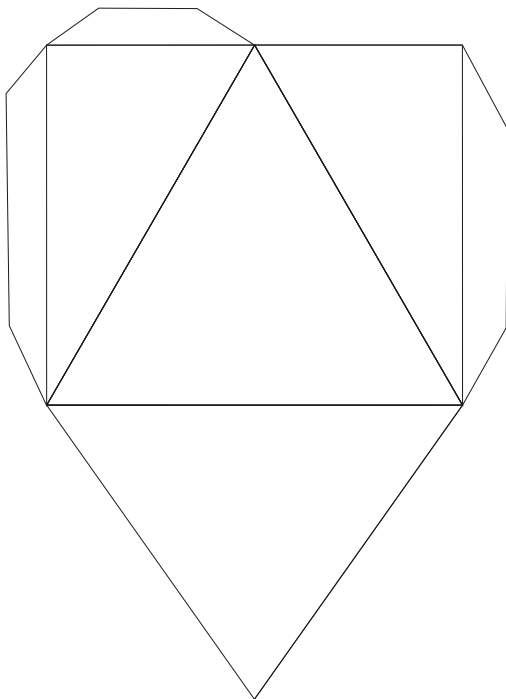
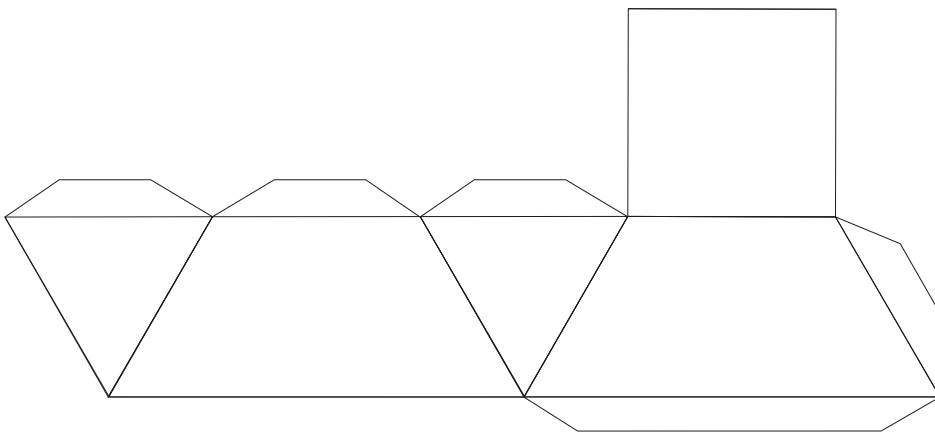
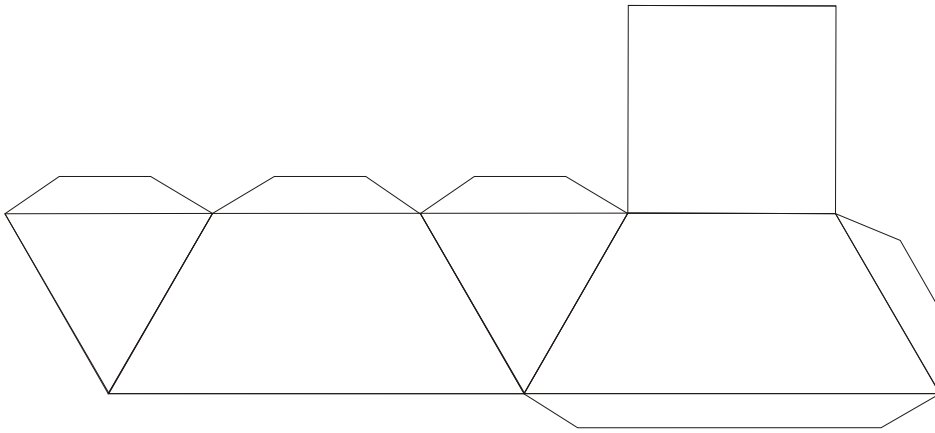

Icosahedron divided in two parts (part 1)

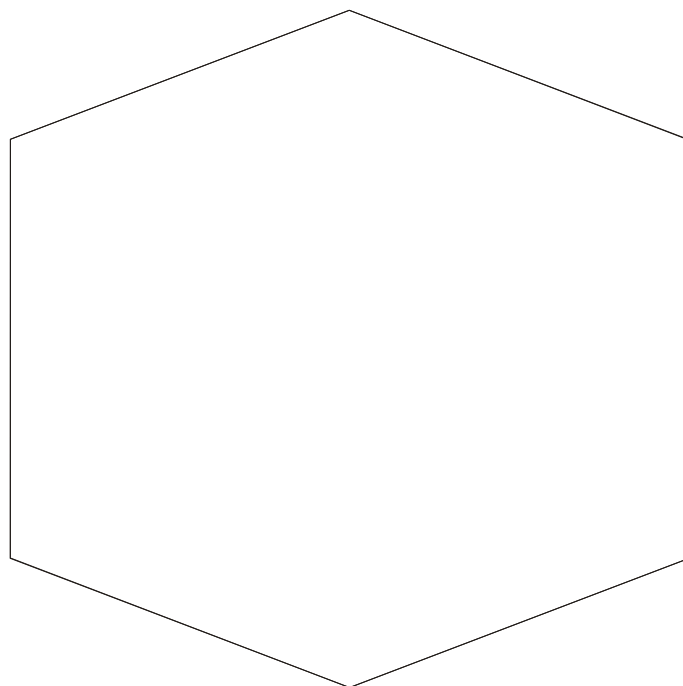
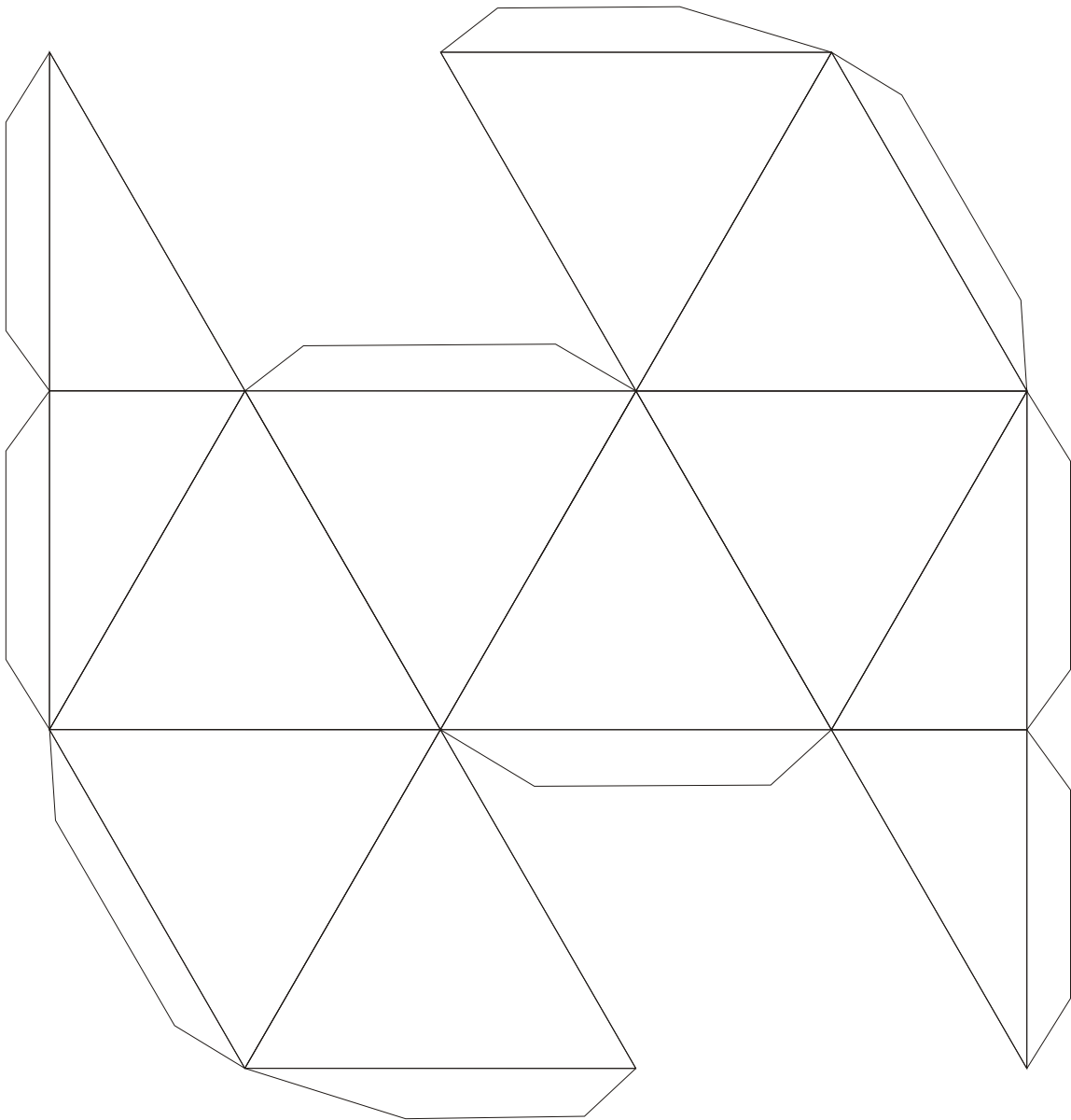

Icosahedron divided in two parts (part 2)

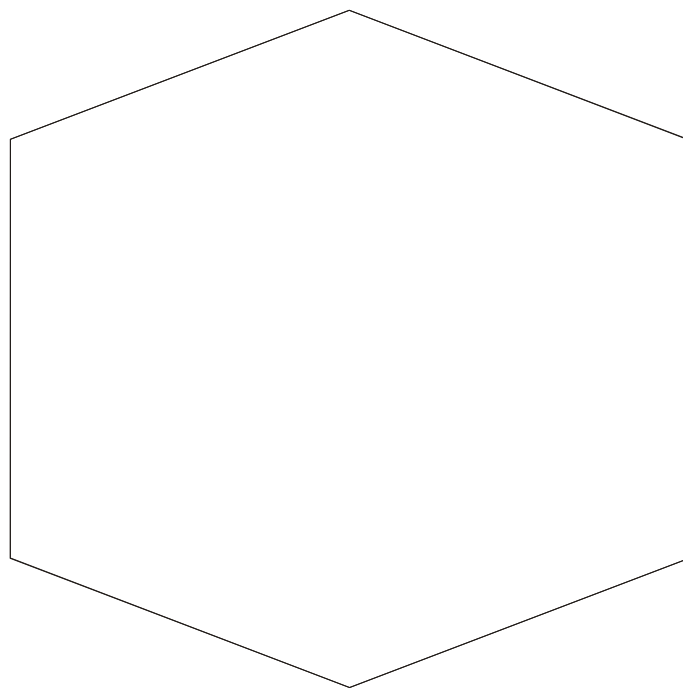
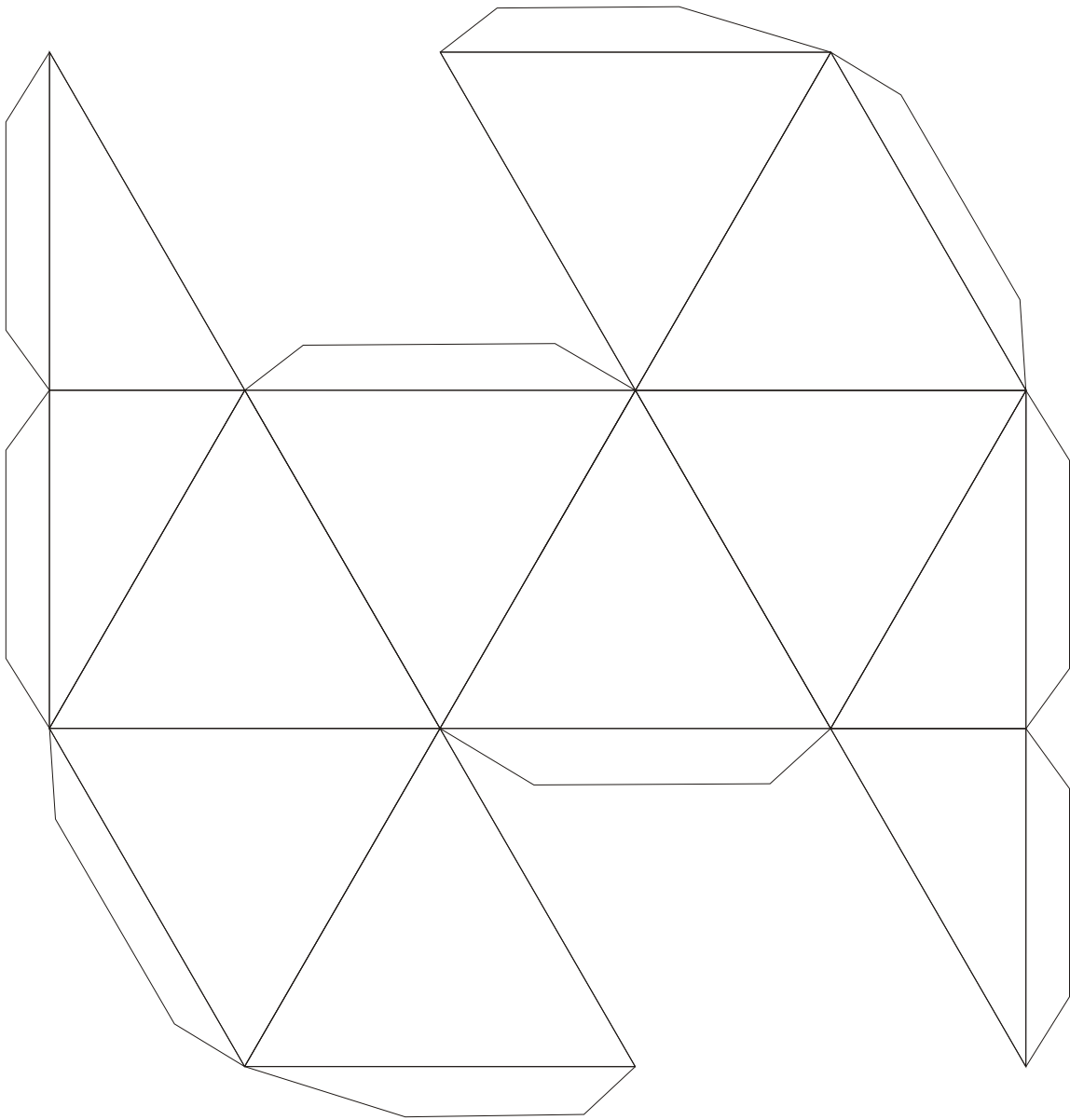

Icosahedron divide in two part (part 1)

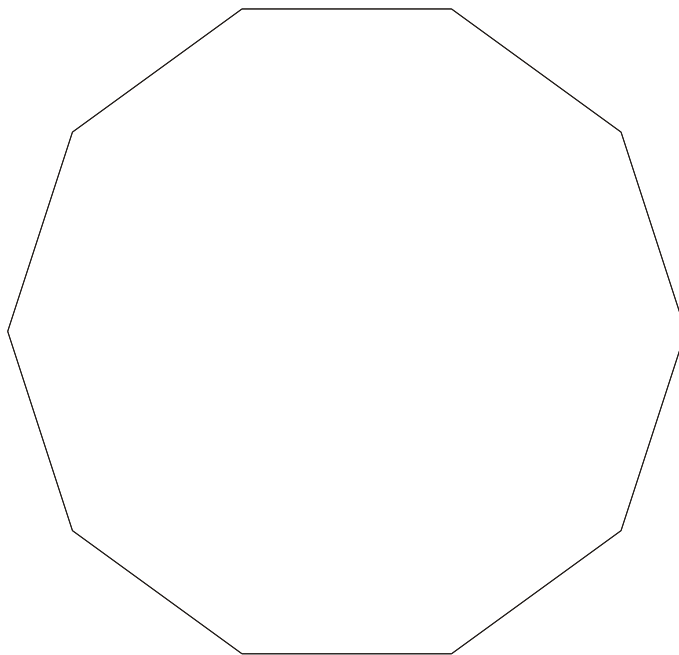
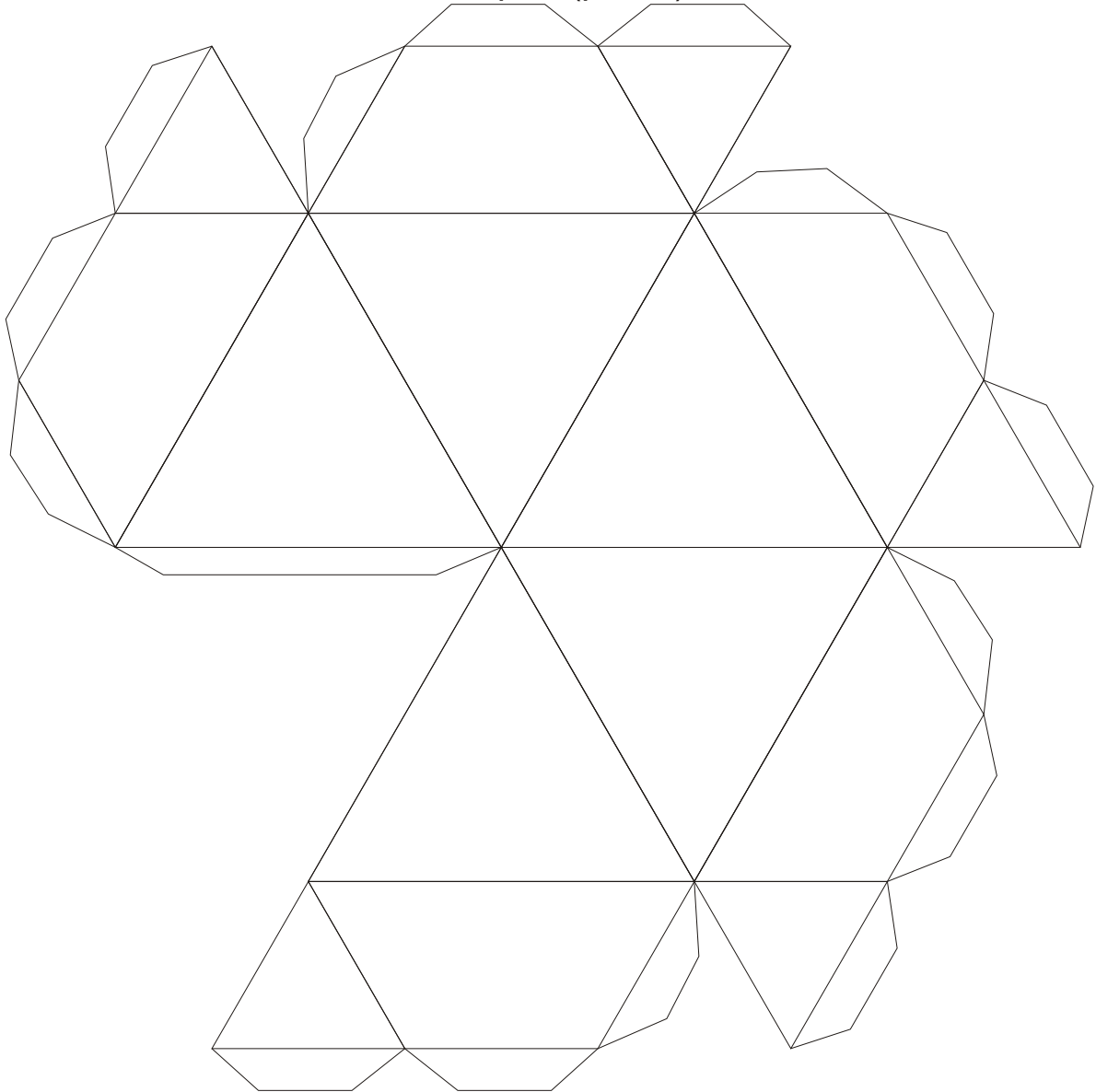

Icosahedron divide in two part (part 2)

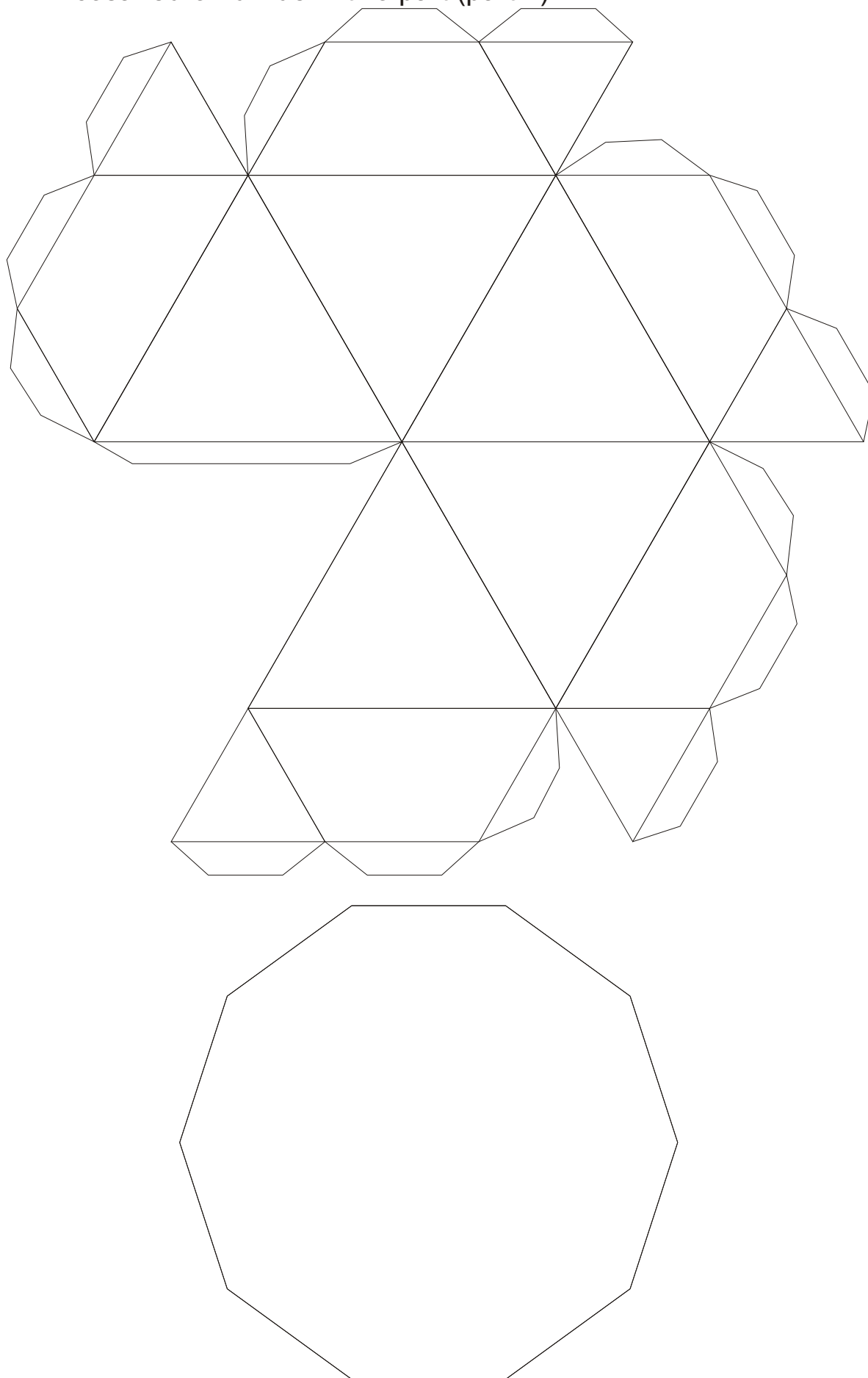

Octahedron

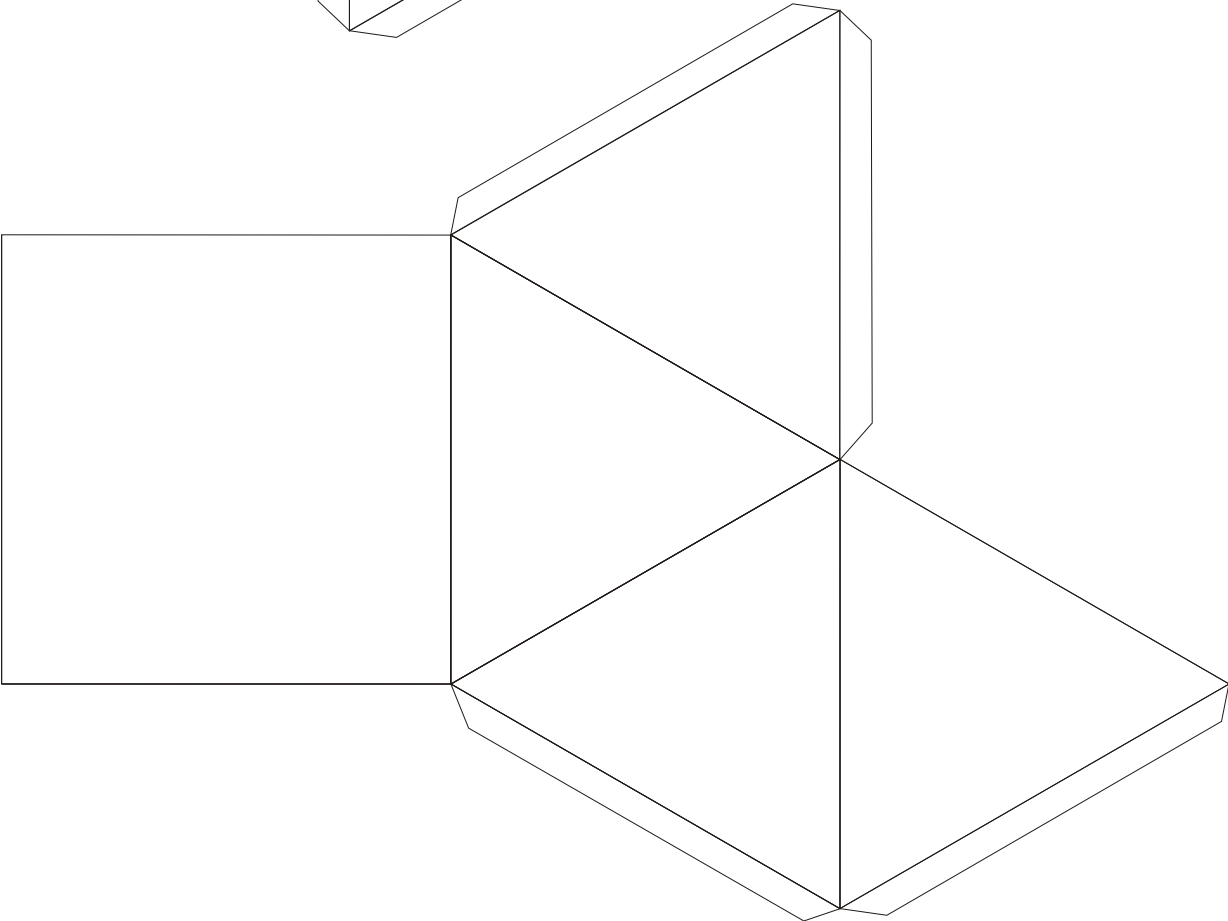
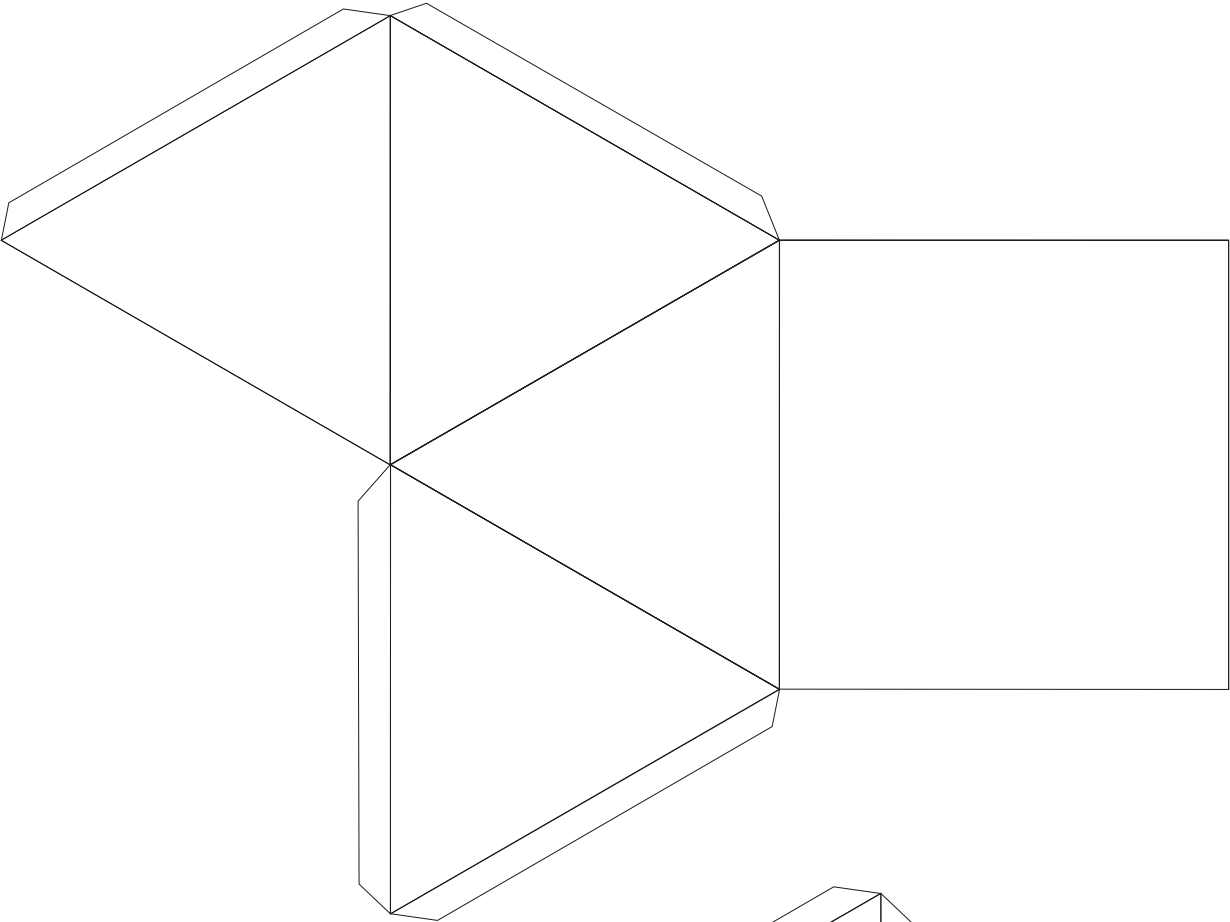

Octahedron

